

**Syntron®
Screening Feeders**

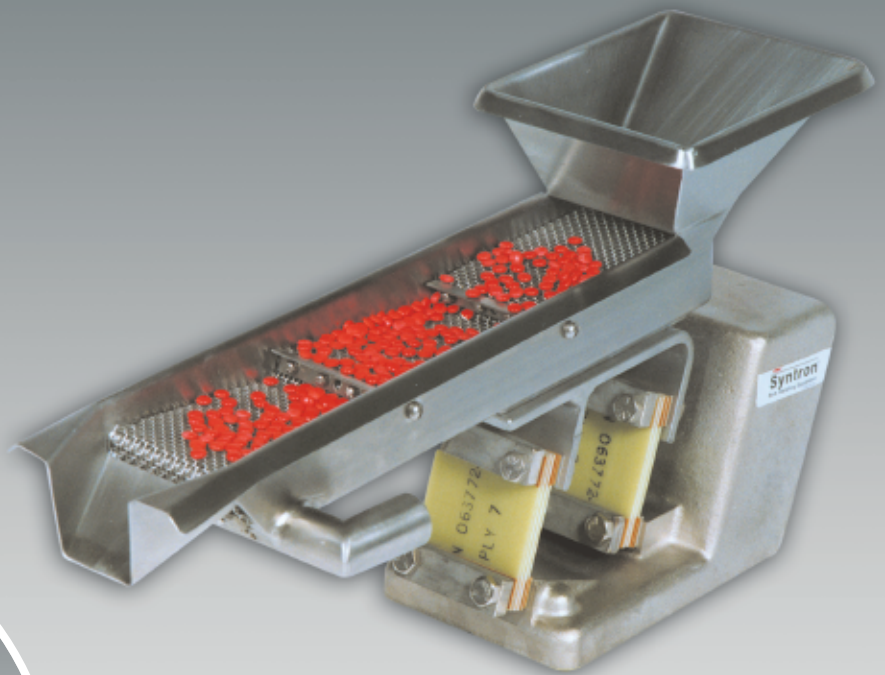

Syntron Material Handling

Look to Syntron Material Handling for exceptional value and performance in bulk material handling. For nearly 70 years, we've partnered with our customers to solve material handling and parts handling requirements in the most demanding and diverse industries and applications. Our Syntron® line—backed by our expert team of engineers, application specialists and sales engineers—sets the standard for quality, performance and reliability.

Syntron Material Handling is committed to complete customer satisfaction, with fast, efficient solutions for most bulk handling applications. From state-of-the-art electronic data capabilities, to expert sales and engineering support specialists, we're focused on ensuring a smooth design, production and installation process—from start to finish.

Syntron®

Screening Feeders

The mechanical process of sizing, classifying, separating oversize materials, fines and/or free-flowing liquid from a bulk product.

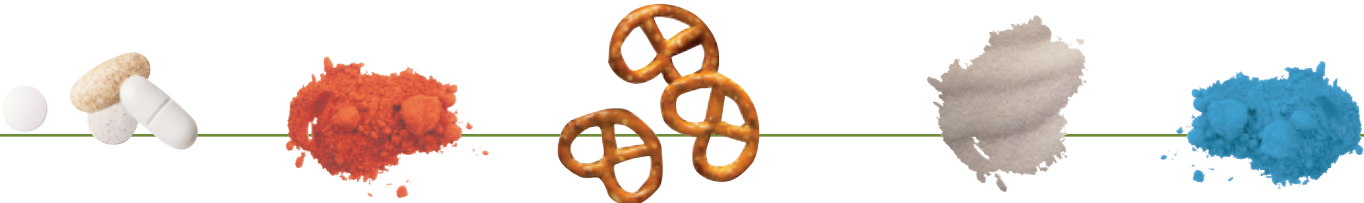

Syntron® Screening Feeders

Syntron® Screening Feeders provide efficient, trouble-free operation for all types of screening applications. The thirteen Screening Feeder models range in size from a 3-inch screen for pharmaceutical and food processing applications to the 4-foot wide trough of the massive Model SF-660 unit used in basic industries.

All models are powered by highly-efficient electromagnetic drives. Unlike motor-driven screening equipment, these units have no moving parts such as eccentrics, bearings, gears or v-belts and, therefore, require no lubrication. The electromagnetic drives combine high-frequency vibration with low amplitude. This permits the handling of delicate materials with minimal product degradation.

The material flow rates of all Screening Feeders are easily regulated and varied. Each unit is furnished with a separate control to set the conveying speed for most effective screening.

Model SF Screening Feeders offer a wide selection of units for sizing, separating, dedusting and dewatering bulk materials. Models SF-T01, SF-010, SF-152 and SF-212 are designed for efficient screening of fine mesh materials. The larger models provide high tonnage separation, dedusting, desilting and dewatering of materials.

A special Light Capacity Screening Feeder used in the processing of pharmaceutical products, particularly in the dedusting of molded tablets is also available. Using all stainless steel construction, the screen is arranged in steps, providing agitation of the flow of tablets and assisting in dust removal through the screen openings into the trough bottom and discharge through the integral spout. Only whole tablets, with dust and chips removed, pass over the screen to the next step in processing.



Model SFH-22 with 12 x 36-inch trough fitted with 1/2mm woven screen cloth.

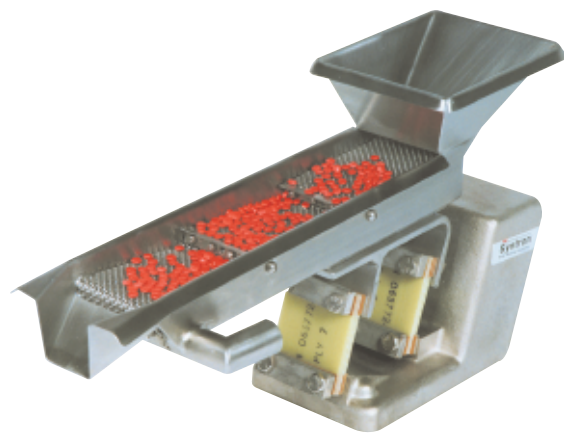

Syntron® SF-T01 pill deduster.

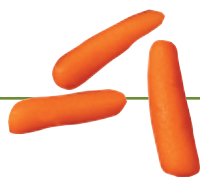
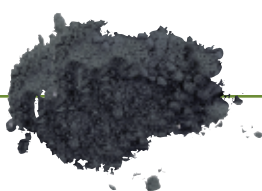

In addition to the conventional, single-deck units, many models are available in two-deck designs. All models can be furnished with various types of screening surfaces such as woven wire cloth, profile wire or perforated plate. Covers can also be added for dust-tight or weather-tight applications.

For those installations having structural barriers or other processing equipment in the area that prevent use of the standard below deck magnet design, the alternative of over-head magnet can always be used.

Syntron® Screening Feeders are available in a wide range of voltages. Please contact Syntron Material Handling's Application Specialists for your specific requirements.

Selection of the proper Screening Feeder for your specific application depends upon material characteristics, tonnage feeding requirements and special processing operations. Your local Syntron Material Handling Sales Engineer can assist you with Syntron Screening Feeder application and selection information.



A custom-built SFM-212 Syntron® Volumetric Screening Feeder Machine

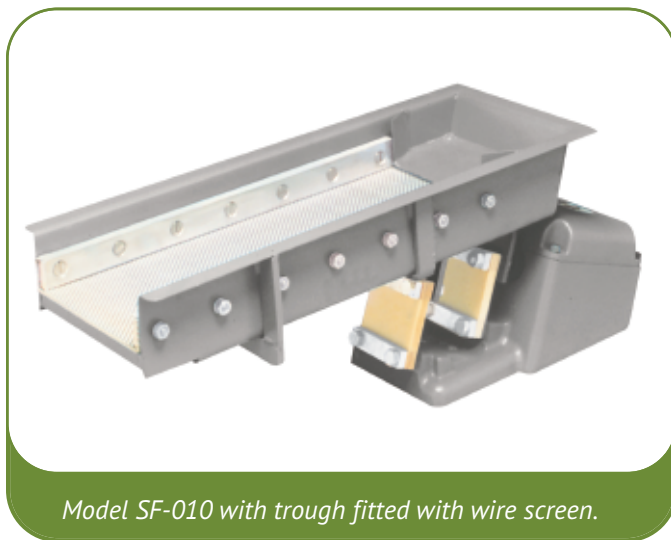

Model SF-010 with trough fitted with wire screen.



Model SFH-22 with dust-tight enclosure.

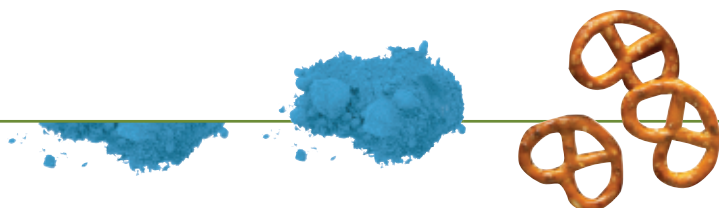

Syntron® Screening Feeders Specifications and Dimensions

Specifications

Model	Current Input-Amps ■	Net Weight (lbs)	Net Weight Control (lbs)	Shipping Weight Outfit (lbs)
115 V, 60 Hz				
SF-T01	0.9	33	5	60
SF-010	2.0	45	5	70
SF-152	2.5	85	3	125
SF-212	4.5	160	3	245
230 V, 60 Hz				
SFH-22	10.0	460	53	600
SFH-24	13.0	580	53	720
SF-330	28.0	960	53	1050
SF-380	36.0	960	53	1400
SF-440	40.0	2300	53	2450
460 V 60 Hz				
SF-450	25.0	3150	53	3300
SF-480	31.5	4100	53	4300
SF-560	27.0	7000	53	7400
SF-660	31.5	8000	53	8400

■ Other voltages available, please consult Syntron Material Handling Application Specialists for your specific application

SF-T01, SF-010 Dimensions, inches

Model	A	B	C	D	E	F	G	H
SF-T01	3	15	9 ³ / ₄	3	9	5	9 ¹ / ₈	6
	6	10	4 ³ / ₄	3	9	5	9 ¹ / ₈	6
SF-010	6	18	12 ¹ / ₂	3	9	6	10 ⁷ / ₈	6
	8	12	6 ³ / ₄	3	9	6	10 ⁷ / ₈	6

SF-152, SF-212 Dimensions, inches

Model	A	B	C	D	F	G	H	J	K	M	N	P	R
SF-152	6	24	5 ³ / ₈	3	12	19 ⁷ / ₈	13	4 ¹ / ₂	18	16	6 ³ / ₈	8 ³ / ₄	10 ³ / ₄
	8	18	8 ³ / ₈	3	12	18 ⁷ / ₈	13	4 ¹ / ₂	18	16	3 ³ / ₈	8 ³ / ₄	12 ³ / ₄
SF-212	8	36	4 ⁷ / ₈	3	15	24 ⁷ / ₈	15 ⁷ / ₈	5 ⁵ / ₈	20 ⁷ / ₈	19	14	12	13
	12	24	10 ⁷ / ₈	3	15	24 ³ / ₈	15 ⁷ / ₈	5 ⁵ / ₈	20 ⁷ / ₈	19	7 ⁷ / ₈	12	17

SF-22 through SF- 660 Dimensions, inches

Model	A	B	C	D	E	F	G	H
SFH-22	14	42	8	5	29 ¹ / ₂	19 ³ / ₄	30 ³ / ₄	21 ¹ / ₂
SFH-24	14	42	8	5	29 ¹ / ₂	19 ³ / ₄	30 ³ / ₄	21 ¹ / ₂
SF-330	18	42	20	6	35 ³ / ₄	24 ³ / ₄	41	26 ³ / ₄
SF-380	24	42	20	6	35 ³ / ₄	26 ¹ / ₄	41	26 ³ / ₄
SF-440	24	54	26	7	45 ³ / ₄	38	49 ¹ / ₂	35 ³ / ₄
SF-450	30	60	22 ¹ / ₄	7	44 ³ / ₄	38	49 ¹ / ₄	34 ³ / ₄
SF-480	30	72	15	10	48 ¹ / ₂	38	62 ¹ / ₂	35
SF-560	36	72	41	12	61	63 ¹ / ₂	76	49
SF-660	48	72	41 ¹ / ₄	12	61	63 ¹ / ₂	76 ¹ / ₂	49

SF-T01

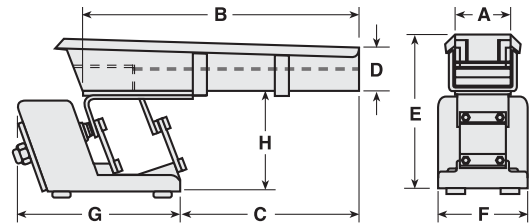

SF-010

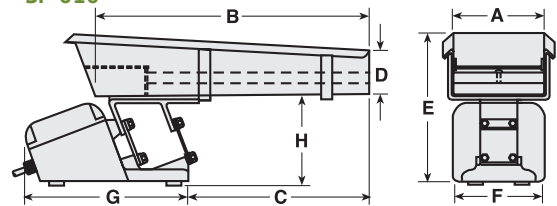

SF-152, SF212

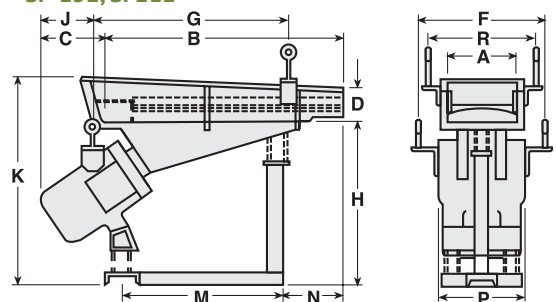

SFH-22 through SF-660

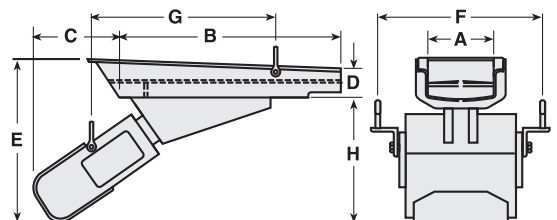

Syntron Material Handling

Corporate Office

P.O. Box 1370

Tupelo, Mississippi 38802

Phone: 662.869.5711

Fax: 662.869.7449

Proven Engineered Products – Complete Material Handling Solutions

Syntron®
Link-Belt®

Saltillo

2730 Hwy 145 South

Saltillo, Mississippi 38866

Phone: 662.869.5711

Fax: 662.869.7493

Toll Free: 800.356.4898

info@syntronmh.com

Changshu

#2 Road No. 1

Changshu Export Processing Zone

Changshu, Jiangsu, China 215513

Phone: +86 0512.52299002

Fax: +86 0512.52297228

info@syntronmh.com