

Syntron Material Handling

**Syntron®
Heavy-Duty Feeders**



Contents

Syntron® Heavy Duty Feeders

Syntron Material Handling	
Proven Engineered Products – Complete Material Handling Solutions	3
Syntron® Heavy-Duty Vibrating Feeders	5
Syntron® Electromagnetic Feeders	6
Model FH-22	8
Model FH-24-HP	8
Model F-380-HP	9
Model F-480-HP	9
Model F-660	10
Model F-88	10
Electromagnetic Feeder Troughs	11
Multiple-Drive Unit Electromagnetic Feeders	12
Syntron® Feeder Controls	14
Heavy-Duty Electromagnetic Feeder Controls	14
Syntron® MF Electromechanical Feeders	18
Model MF-200-DD	20
Model MF-400-DD	21
Model MF-600-DD	21
Model MF-800-DD	22
Model MF-1000-DD	22
Model MF-1600	23
Model MF-2000	23
MF Heavy-Duty Feeder Trough Styles	24
Syntron® HP Electromechanical Feeders	26
Model MF-300-DD	28
Model MF-500-DD	28
Model MF-1100-DD	29
SYNTRO-FLO Cone Crusher Loading Feeders by Syntron®	30
Model STF-3F, STF-4F, & STF-5F	31
Electromechanical Feeder Controls	32
Electromechanical Feeder Control Dimensions	33
Recommended Installation Guidelines	34
Recommended Designs for Hoppers and Transitions	34
Recommended Hopper Design and Feeder Selection	35
Feeder Mounting and Isolation	36
Syntron® Vibrators	37
Vibrator Data Sheet	38
Heavy Duty Electromagnetic & Electromechanical Feeder Data Sheet	39



Syntron Material Handling

Proven Engineered Products – Complete Material Handling Solutions

Two powerful industry leading brands—**Link-Belt®** and **Syntron®**—have come together under a new company name, Syntron Material Handling, LLC, for one goal – better engineered products.

Established in May 2014, Syntron Material Handling (SMH) was built out of the legacies of Link-Belt Company and Syntron Company, formerly owned by FMC Technologies. Today, our 300 skilled employees have a combined 4,212 years of industry knowledge that they put into the SMH product every day. We are dedicated to providing customers with complete material handling solutions.

Let Syntron Material Handling's knowledgeable team help your business with conveying, feeding, screening, elevating, vibratory flow aids, and mining controls of bulk product. Whether optimizing existing systems or starting from the ground-up on new and customized plants or mines, our dedicated staff will provide you with the most efficient and cost-effective solutions.

"Our company structure will be very exciting and fast-paced as we charter our new path. The positive attitudes and skills of our employees, the strength of our products, and our long-term customer relationships are our foundation for success." said CEO Andy Blanchard.

An international leader for innovative solutions, Syntron Material Handling can improve the technology customers are already using. The Link-Belt® expertise and equipment have been instrumental in developing some of the world's largest belt conveyors. The Syntron® feeders are instrumental to supplying energy sources and material handling efforts across the globe.

Levine Leichtman Capital Partners, the new owner of Syntron Material Handling, is committed to the success and growth of the company by investing in engineering capabilities, manufacturing efficiency, and customer service.

Although we may have a new name, we still have the same dedicated employees and industry leading engineered products that make us a market leader.

Syntron Material Handling operates two manufacturing facilities in the USA and China.

All of our products are produced to OSHA/MSHA standards and ISO Standard 9001:2008. We are a charter member of CEMA, and active members of NSSGA, NMA, SME, FEMA, and PMMI.



Call us today for all your material handling needs.

Saltillo
2730 Hwy 145 South
Saltillo, Mississippi 38866
Phone: 662.869.5711
Fax: 662.869.7493
800.356.4898
orders@syntronmh.com

Changshu
#2 Road No. 1
Changshu Export Processing Zone
Changshu, Jiangsu, China 215513
Phone: +86 0512.52299002
Fax: +86 0512.52297228

Syntron Material Handling

Service and Support

At Syntron Material Handling, we understand that good, reliable equipment – operating at peak performance – is crucial to your bottom line. That's why we're committed to giving our customers value – before, during and after the sale.

Syntron® Material Handling is based on the most rugged, reliable, and durable vibratory equipment available – Syntron vibrating feeders, conveyors, screens, and bin vibrators. To begin with, we'll help you select the right equipment, considering all the variables of your application in order to maximize production and reduce costs.

Once you're up and running, our Syntron Services Team will keep you on top and moving ahead. We're on call – at the factory or in the field – wherever and whenever you need us for parts, service, inspection and training.

Dependable equipment is critical to your operation, and your success is critical to our success. At Syntron Material Handling, your satisfaction is our number one priority. You can rely on us.

www.syntronmh.com



Syntron® Heavy-Duty Vibrating Feeders

Syntron® Vibrating Feeders for heavy industry are ideal for feeding a wide variety of bulk materials from storage piles, hoppers, bins and silos. Rugged and dependable, Syntron® heavy-duty feeders are backed by years of service with proven performance in the mining, aggregates, glass, cement, chemical, wood products and steel industries.

Syntron Vibrating Feeders are designed to increase bulk handling productivity with high feed rates to improve cost-per-ton efficiency. Electromagnetic and electromechanical models are available with capacity ranges from 25 to 4,000 tons per hour. Feeder selection should consider the production requirements, material characteristics, and operating environment.

Syntron® Vibrating Feeders are sub-resonant tuned, two-mass, spring-connected systems. These features enable Syntron® feeders to work consistently under material damping and other varying headload conditions with negligible changes in trough stroke. Sub-resonant tuning maintains stroke consistency and speed stability, thus delivering higher capacities at controlled feed rates.

Precise, sub-resonant tuning is a key characteristic of both types of Syntron® vibrating feeders. Electromagnetic models are tuned through careful calculation of the number and thickness of the special leaf springs required to accomplish the desired tuning ratio. Electromechanical models are tuned by adjusting the operating speed to obtain the exact tuning ratio. Low sub-resonant tuning utilized by Syntron®'s two-mass feeders make them the most stable and consistent feeders available in today's market.

Dependable, flexible control sets Syntron® vibrating feeders apart from other feeding and conveying machinery. Material feed rates are controlled and easily adjusted with Syntron® feeder controls; a wide range of standard and special models is available. Control devices can also be supplied for integration into systems that use external signals from automatic sensing devices. In addition, control arrangements are available for selecting and sequencing a group of feeders.

Electromagnetic Feeder



Syntron® F-Series
Electromagnetic Feeder

Electromechanical Feeders



Syntron® MF
Electromechanical Feeder

Syntron® Electromagnetic Feeders

Heavy-Duty Electromagnetic Feeders

With thousands of units installed over the past 60 years, Syntron® Heavy-Duty Electromagnetic Feeders are the most recognized name in the industry. With models having capacities ranging from 25 to 1,600 tons per hour, these feeders are capable of handling a variety of materials from fine powder to large, coarse particles.

Syntron® Electromagnetic Feeders are two-mass sub-resonant tuned. When the natural frequency of a feeder is greater than the operating frequency (3600 VPM), the feeder is sub-resonant tuned, which makes the unit consistent and stable under changing headloads. The units can be supplied in various configurations including multiple-drive units for especially long or wide pans and above-deck drive units for applications where space under the trough is insufficient for the standard below-deck unit.

Utilizing the EVF control, Syntron® Electromagnetic Feeders will accept a three-phase input voltage while operating with a rectified ac sine wave to the feeder. This provides for three-phase load balancing to your plant electrical system and reduces the VA load required by the feeder. The units provide easily adjustable feed rates with an instantaneous response. (For more information on electromagnetic controls, see pages 14-16.)

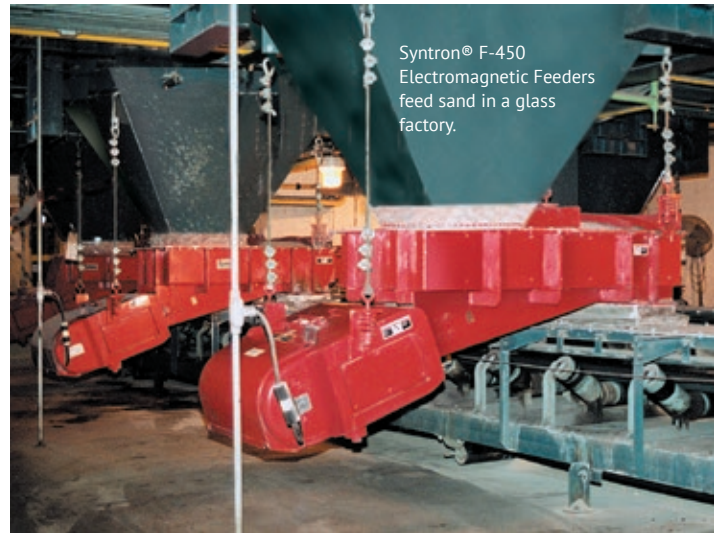

Syntron® F-450
Electromagnetic Feeders
feed sand in a glass
factory.



Syntron® F-380 Electromagnetic Feeder
with above-deck drive unit evenly
distributes parts at a consistent rate to a
heat treatment furnace.



Feeding gypsum with
Syntron® model F-380
Electromagnetic Feeder.

Syntron® Electromagnetic High Performance Feeder Features

- **Dust-tight and maintenance-free drive units:** Feeders have no mechanical parts to wear out, such as cams, eccentrics, belts and bearings - thus eliminating the need for lubrication.
- **Two-mass, spring-connected, sub-resonant tuned:** All movement is confined to the heavy-duty leaf springs which provide millions of cycles of service.
- **Stroke generated by electromagnetic field produced by coil.**
- **High Frequency:** 3600 VPM at 60 Hz or 50 Hz with EVF Control for maximum feed rate.
- **Stroke - .080 inches:** New "HP" units operate at .080" at 3600 VPM to provide 40% more output than traditional units at .060"
- **Troughs:** Engineered weldments designed to withstand the high acceleration and impact forces associated with vibratory feeding applications.
- **Bolt-in replacement trough liners:** Wide range of materials to best fit your applications are available including T-1A, AR-400, AR-500, Stainless Steel, UHMW Plastic, Rubber, Ceramic and Carbide Overlay.

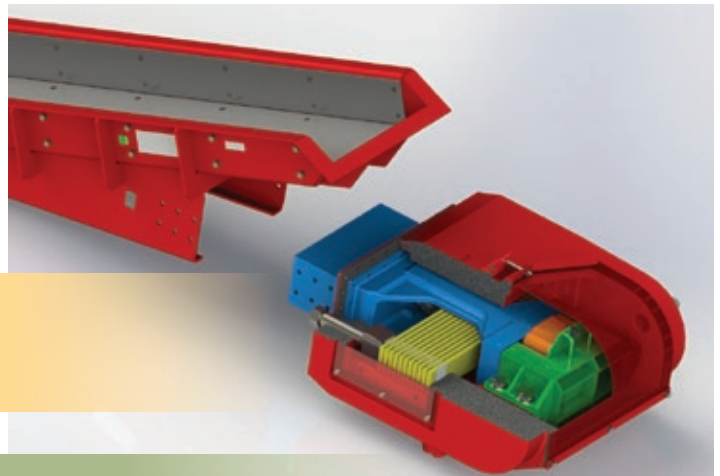

Syntron® Electromagnetic Feeders are ideal for use in a stationary operation such as a tunnel system from a surge pile. They are usually controlled from a remote point to provide the desired feed rate. In this application, a model FH-22 feeds limestone to a belt conveyor.



Electromagnetic Feeder Specifications

MODEL FH-22 (up to 180) tph

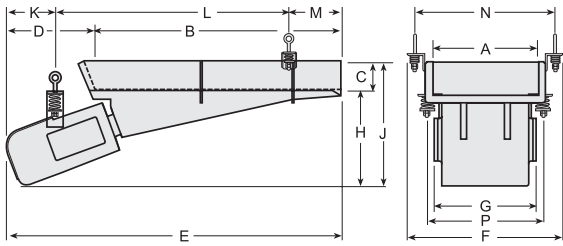

Approx. Trough W x L	Approx. Capacity tph	Approx. Current (460V)	Control Model	Net Wt. (lb)	Net Wt. (kg)	Approx. Ship Wt. (lbs) Feeder/Control	Approx. Ship Wt. (kg) Feeder/Control
12 x 60	50	5 amps	EVF-7.5D	480	217	575	260
18 x 42	125	5 amps	EVF-7.5D	460	208	555	251
24 x 42	180	5 amps	EVF-7.5D	480	217	575	260

Please request a certified drawing for installation.

◆ Based on feeder with 10° down slope, below-deck drive unit, installed with proper hopper transition and skirt board arrangement, feeding sand weighing 100 pounds per cubic foot. 240/480/600 Volt 60 Hz single-phase. 230/400/415 Volt 50 Hz single-phase. Above-deck and base mounting drive units are available.

	A	B	C	D	E	F	G	H	J	K	L	M	N	P
in	12	60	5	6 1/2	66 1/2	23	17 1/2	16 1/2	21 1/2	8 3/4	47 3/4	10 1/2	18 3/4	19 3/4
mm	305	1524	127	165	1689	584	445	419	546	210	1213	267	476	502
in	18	42	5	15 5/16	57 5/16	26 3/4	17 1/2	18	23	8 5/16	40	9	24 3/4	19 3/4
mm	457	1067	127	389	1456	679	445	457	584	211	1016	229	629	502
in	24	42	5	15 5/16	57 5/16	32 3/4	17 1/2	18	23	8 5/16	40	9	30 3/4	19 3/4
mm	610	1067	127	389	1456	832	445	457	584	211	1016	229	781	502

MODEL FH-24-HP (up to 235) tph

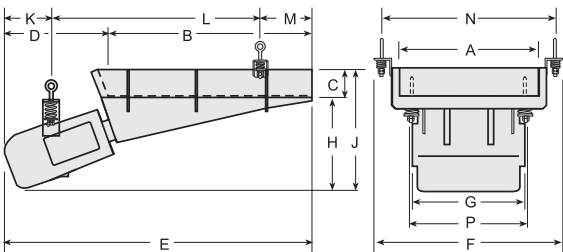

Approx. Trough W x L	Approx. Capacity tph	Approx. Current (460V)	Control Model	Net Wt. (lb)	Net Wt. (kg)	Approx. Ship Wt. (lbs) Feeder/Control	Approx. Ship Wt. (kg) Feeder/Control
18 x 60	125	7 amps	EVF-7.5D	600	272	650	294
24 x 48	235	7 amps	EVF-7.5D	600	272	650	294
30 x 36	200	7 amps	EVF-7.5D	600	272	650	294

Please request a certified drawing for installation.

◆ Based on feeder with 10° down slope, below-deck drive unit, installed with proper hopper transition and skirt board arrangement, feeding sand weighing 100 pounds per cubic foot. 240/480/600 Volt 60 Hz single-phase. 230/400/415 Volt 50 Hz single-phase. Above-deck and base mounting drive units are available.

	A	B	C	D	E	F	G	H	J	K	L	M	N	P
in	18	60	5	6 5/16	66 5/16	28	19 5/8	18	23	8 5/16	47 1/2	10 1/2	24 3/4	24 3/4
mm	457	1524	127	160	1684	711	498	457	584	211	1207	267	629	629
in	24	48	5	12 5/16	60 5/16	32 3/4	19 1/4	18	23	8 5/16	41 7/8	10 1/8	30 3/4	19 3/4
mm	610	1219	127	313	1532	832	489	457	584	211	1064	257	781	502
in	30	36	5	8 5/16	54 5/16	38 3/4	19 1/4	18	23	8 5/16	37	9	36 3/4	19 3/4
mm	762	914	127	135	1380	984	489	457	584	211	940	229	933	502

Many other trough sizes are available. Capacities vary depending on drive unit location, material characteristics, material density, trough length and width, trough liner type, feeder installation, skirt boards and hopper transitions. Cad drawings are available. Please call Syntrol Material Handling for expert help with your application.

MODEL F-380-HP (up to 500) tph

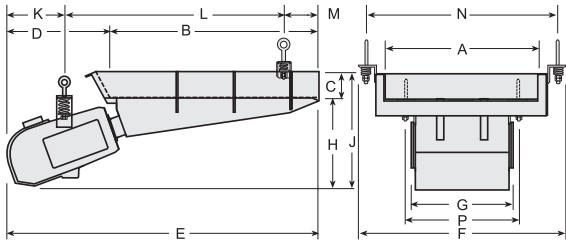

Approx. Trough W x L	Approx. Capacity tph	Approx. Current (460V)	Control Model	Net Wt. (lb)	Net Wt. (kg)	Approx. Ship Wt. (lbs) Feeder/Control	Approx. Ship Wt. (kg) Feeder/Control
24 x 60	250	18 amps	EVF-15D	1370	621	1400	635
30 x 60	500	18 amps	EVF-15D	1400	635	1450	657
36 x 48	500	18 amps	EVF-15D	1400	635	1450	657

Please request a certified drawing for installation.

◆ Based on feeder with 10° down slope, below-deck drive unit, installed with proper hopper transition and skirt board arrangement, feeding sand weighing 100 pounds per cubic foot. 240/480/600 Volt 60 Hz single-phase. 230/400/415 Volt 50 Hz single-phase. Above-deck and base mounting drive units are available.

	A	B	C	D	E	F	G	H	J	K	L	M	N	P
in	24	60	6	18 1/8	78 1/8	35 7/8	23 1/4	22 3/4	28 3/4	12 7/8	50 3/4	14 1/2	32 5/8	32
mm	610	1524	152	460	1984	911	591	578	730	327	1289	368	829	813
in	30	60	6	18 1/8	78 1/8	41 7/8	23 1/4	22 3/4	28 3/4	12 7/8	50 3/4	14 1/2	38 5/8	36
mm	762	1524	152	460	1984	1064	591	578	730	327	1289	368	981	91
in	36	48	6	24 1/8	72 1/8	47 7/8	23 1/4	22 3/4	28 3/4	12 7/8	50 3/4	8 1/2	44 5/8	26 1/4
mm	914	1219	152	613	1832	1016	591	578	730	327	1289	216	1133	666

MODEL F-480-HP (up to 1100) tph

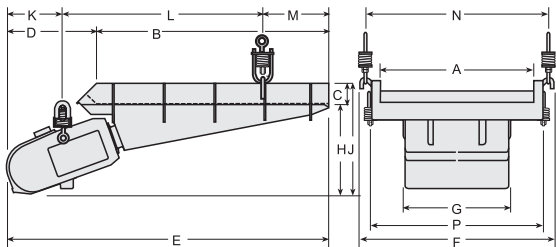

Approx. Trough W x L	Approx. Capacity tph	Approx. Current (460V)	Control Model	Net Wt. (lb)	Net Wt. (kg)	Approx. Ship Wt. (lbs) Feeder/Control	Approx. Ship Wt. (kg) Feeder/Control
42 x 84	1100	31.5 amps	EVF-25D	4100	1859	4200	1905
48 x 72	1100	31.5 amps	EVF-25D	4000	1814	4100	1859

Please request a certified drawing for installation.

◆ Based on feeder with 10° down slope, below-deck drive unit, installed with proper hopper transition and skirt board arrangement, feeding sand weighing 100 pounds per cubic foot. 480/600 Volt 60 Hz single-phase. 400/415 Volt 50 Hz single-phase. Above-deck and base mounting drive units are available.

	A	B	C	D	E	F	G	H	J	K	L	M	N	P
in	42	84	7	23 15/16	107 15/16	54 3/8	33	30 11/16	37 11/16	17 7/16	71 1/2	19	50 3/4	51
mm	1067	2134	178	608	2742	1381	838	779	957	443	1816	483	1289	1295
in	48	72	7	28 1/16	100 1/16	60 3/8	33	27 13/16	34 13/16	17 1/2	61 5/8	21	56 3/4	57
mm	1219	1829	178	713	2542	1534	838	706	884	445	1565	533	1441	1448

Many other trough sizes are available. Capacities vary depending on drive unit location, material characteristics, material density, trough length and width, trough liner type, feeder installation, skirt boards and hopper transitions. Cad drawings are available. Please call Syntrol Material Handling for expert help with your application.

Electromagnetic Feeder Specifications

MODEL F-660

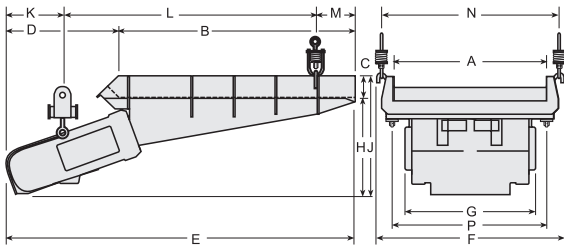

Approx. Trough W x L	Approx. Capacity tph	Approx. Current (460V)	Control Model	Net Wt. (lb)	Net Wt. (kg)	Approx. Ship Wt. (lbs) Feeder/Control	Approx. Ship Wt. (kg) Feeder/Control
60 x 90	1000	31.5 amps	EVF-25D	9200	4173	9300	4218

Please request a certified drawing for installation.

◆ Based on feeder with 10° down slope, below-deck drive unit, installed with proper hopper transition and skirt board arrangement, feeding sand weighing 100 pounds per cubic foot. 480/600 Volt 60 Hz single-phase. 400/415 Volt 50 Hz single-phase. Above-deck and base mounting drive units are available.

	A	B	C	D	E	F	G	H	J	K	L	M	N	P
in	60	90	8	40	130	72 ½	51 ½	39 ½	47 ½	21 ½	96	15 ½	69	63 ½
mm	1524	2286	203	1016	3302	1842	1308	1003	1207	546	2438	394	1753	1613

MODEL F-88

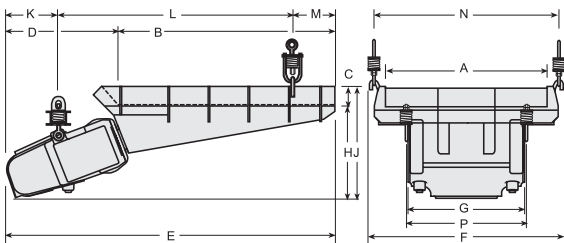

Approx. Trough W x L	Approx. Capacity tph	Approx. Current (460V)	Control Model	Net Wt. (lb)	Net Wt. (kg)	Approx. Ship Wt. (lbs) Feeder/Control	Approx. Ship Wt. (kg) Feeder/Control
72 x 96	1600	70 amps	EVF-60D	11400	5170	12000	5443

Please request a certified drawing for installation.

◆ Based on feeder with 10° down slope, below-deck drive unit, installed with proper hopper transition and skirt board arrangement, feeding sand weighing 100 pounds per cubic foot. 480/600 Volt 60 Hz single-phase. 400/415 Volt 50 Hz single-phase. Above-deck and base mounting drive units are available.

	A	B	C	D	E	F	G	H	J	K	L	M	N	P
in	72	96	8	49 9/16	145 9/16	87	51 ½	40 3/32	48 3/32	22 3/4	103 9/16	19 1/4	82	63 ½
mm	1829	2438	203	1259	3697	2210	1308	1018	1222	578	2630	489	2083	1613

Many other trough sizes are available. Capacities vary depending on drive unit location, material characteristics, material density, trough length and width, trough liner type, feeder installation, skirt boards and hopper transitions. Cad drawings are available. Please call Syntron Material Handling for expert help with your application.

Electromagnetic Feeder Troughs

Syntron® Electromagnetic Feeder models FH-22 through F-88 can be furnished with standard flat-bottom troughs, special flat-bottom troughs or belt-centering discharge troughs.

Drive units can be positioned either above or below the trough. A below-deck drive unit is most commonly used, but above-deck drive units can be supplied for installations where there is insufficient space below the trough. However, an above-deck drive unit may reduce feeder capacity slightly.

Several trough options are available for special applications. Syntron® extra-long feeder troughs can be supplied with either below-deck or above-deck multiple electromagnetic drive units. Extra-long feeder troughs provide many advantages in conveying materials over long distances; unlike belt conveyors, there are no idlers or pulley drive units to wear, lubricate, or replace. Long tubular troughs can convey pure, clean materials without atmospheric contamination and safely convey dusty, poisonous materials without endangering processing personnel.

Other trough options include:

- Syntron® vibrating inspection tables feed material forward at a smooth, controlled rate of flow. This enables an operator to remove material that does not meet specification.
- Syntron® “spreader” feeders spread a wide, even layer of material with a diagonal discharge trough or diagonal-slotted trough.



Standard flat-bottom trough, below-deck drive unit.



Tubular trough, below-deck drive unit.



Flat bottom trough, above-deck drive unit.

Other Trough Options Include:

- Covered Trough with Dust Seals
- Open Trough with Dust Seals
- Screening Feeders
- Diagonal Discharge Trough
- Belt-Centering Discharge Trough

Trough Liner Options Include:

- T-1A
- AR-400
- AR-500
- Stainless Steel
- UHMW Plastic
- Rubber
- Ceramic
- Carbide Overlay

Multiple-Drive Electromagnetic Feeders

Syntron® Electromagnetic drive units can be combined to create feeders ideally suited for special applications. Multiple-drive units, positioned one behind the other, result in a long, vibrating conveyor. When an especially wide material layer is desired, multiple-drive units can be placed side by side on extra wide feeder troughs. The number of drive units required is determined by the trough width and length.

Dual-twin drive units – two sets of twin drive units, one set placed behind the other – provide both increased capacity and the ability to handle exceptionally heavy loads.

The material flow rate of all multiple-drive unit models can be easily regulated. A special control permits adjustment of all drive units simultaneously to control the flow rate of the entire feeder.

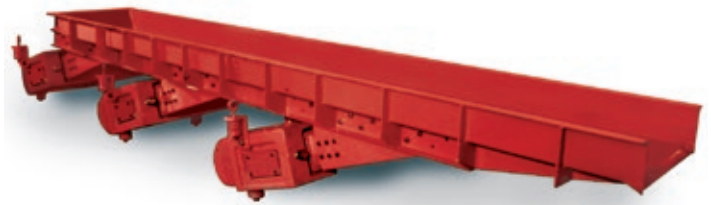

Sixteen foot, triple drive unit
Syntron® F-480 Electromagnetic
Feeder conveyor.



Syntron® F-660 Electromagnetic
Feeder with two drive units.

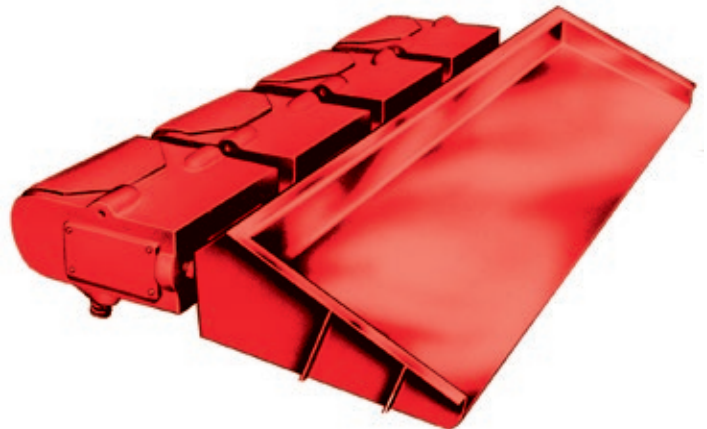

An eight-foot wide by twenty-four
inch long trough powered by four
Syntron® F-380 electromagnetic
drive units.

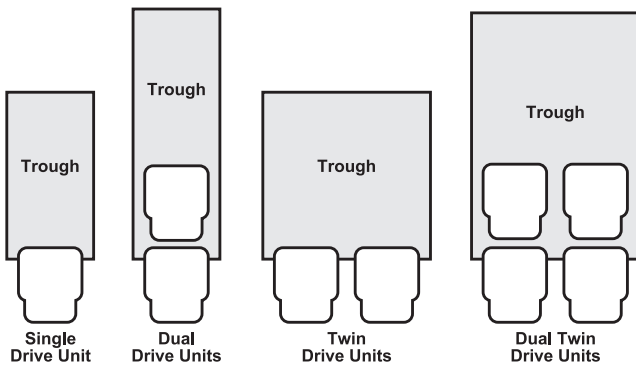

A selection of some of the available multiple-drive unit configurations.

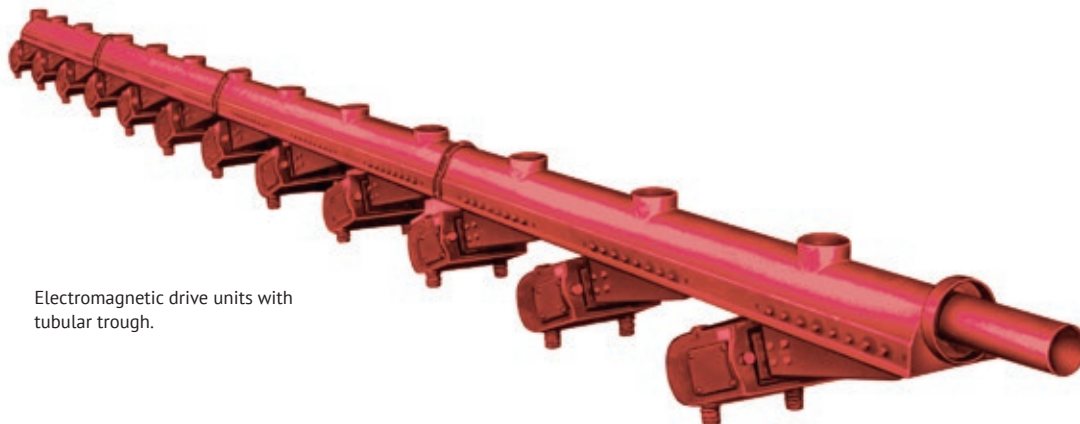

Electromagnetic drive units with
tubular trough.



Syntron® Heavy-Duty Electromagnetic Feeder Controls

Provide for adjustable and consistent material flow

EVF Series Controls are optimized for efficient operation and allow for a full range of material flow with a 10:1 turn-down ratio on electromagnetic feeders. The newly designed EVF line of feeder controls operate with single- or three-phase input providing half-wave (RC) output and are configured with custom firmware thus allowing for reduced power consumption.

EVF Series Control



Additional features of the new EVF product offering include precise voltage regulation, expanded DC control signals and PC communication, and improved diagnostic capability. Please reference the chart below for model offerings or call one of our applications specialists at 1-800-356-4898 for additional information.

Control Model	Input Voltage	Hz		Amps	Enclosure	Intermittent Contacts	DC Signal Input	Manual Control	Output RC	Voltage Regulation	Soft Start	Variable Frequency	Certifications		
		50	60										UL	CUL	CE
EVF-7.5D	230	●	●	20	Nema 1	●	●	Keypad	●	●	●	●	●	●	●
	380-460	●	●	10											
	575-600		●	10											
EVF-15D	230	●	●	40	Nema 1	●	●	Keypad	●	●	●	●	●	●	●
	380-460	●	●	21											
	575-600		●	15											
EVF-25D	230	●	●	60	Nema 1	●	●	Keypad	●	●	●	●	●	●	●
	380-460	●	●	34											
	575-600		●	25											
EVF-60D	380-460	●	●	75	Nema 1	●	●	Keypad	●	●	●	●	●	●	●
	575-600		●	64											

● Standard in the model listed

Electromagnetic Feeder Control Dimensions

Model	Feeder Type	Overall Dims (in.)				Mtg. Dims (in.)					Weight (lbs)	Weight (kg)
		A	B	C	D	E	F	G	H	J		
EVF-7.5D	FH-22-HP, FH-24-HP	7.88	12.72	7.22	3.01	7.31	11.93	0.28	0.12	-	18	8
EVF-15D	F-380-HP	7.88	12.72	7.22	3.01	7.31	11.93	0.28	0.12	-	29	13
EVF-25D	F-480-HP, F-660	9.84	15.90	8.08	4.33	8.90	15.12	0.39	0.39	-	29	13
EVF-60D	F-88	14.57	23.19	10.24	5.22	13.19	22.05	0.51	0.72	0.71	79	35

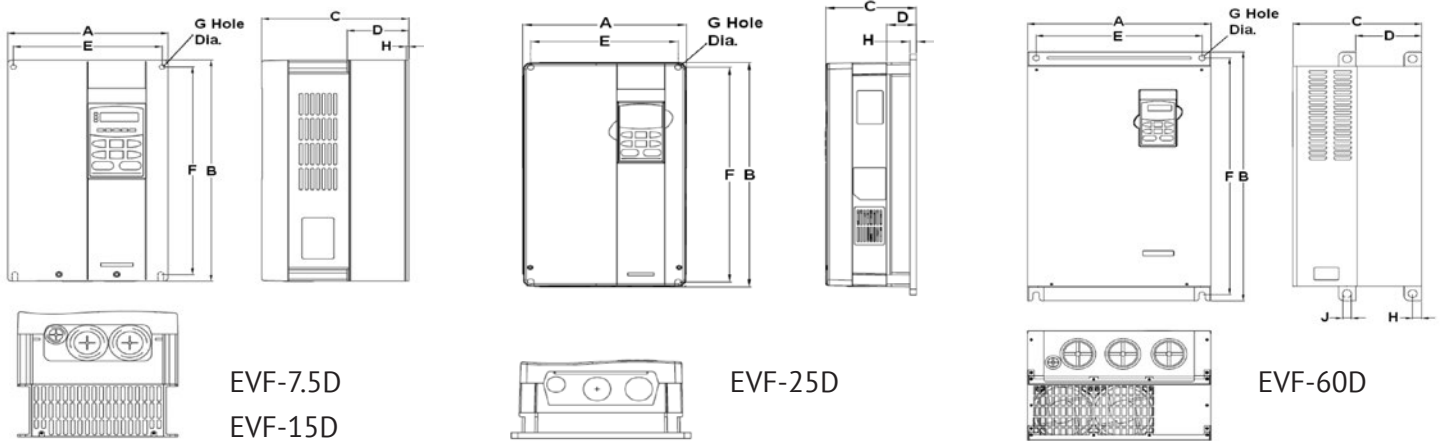

Return on investment!

Utilizing PWM technology with custom firmware and an additional rectifier decreases the amount of amperage being drawn off of the power line by approximately 85%. This design reduces the KW consumption of an electromagnetic feeder by more than half. Power grid installation costs are significantly reduced with lower current capacity requirements. When compared to traditional means of powering electromagnetic equipment, the EVF design practically eliminates the reactive power losses resulting in a reduction of up to 80% in KVA requirement. "The EVF Controls virtually pay for themselves when installed."

Cutting edge technology

Reduced energy consumption

Savings before startup include:

- Smaller transformers
- Smaller conductors (cables or wires)
- Smaller breakers
- Easier to install in MCC
- Less filtration and line conditioning required for other plant equipment
- Reduces the need for Power Factor Correction Equipment
- Easier to integrate with the latest technology for reduction in controls installation

Savings after startup include:

- Over a 50% reduction in energy consumed
- Better diagnostic capabilities to reduce maintenance time
- 100% voltage regulation for consistent production rates

Standard Electronic Feeder Control

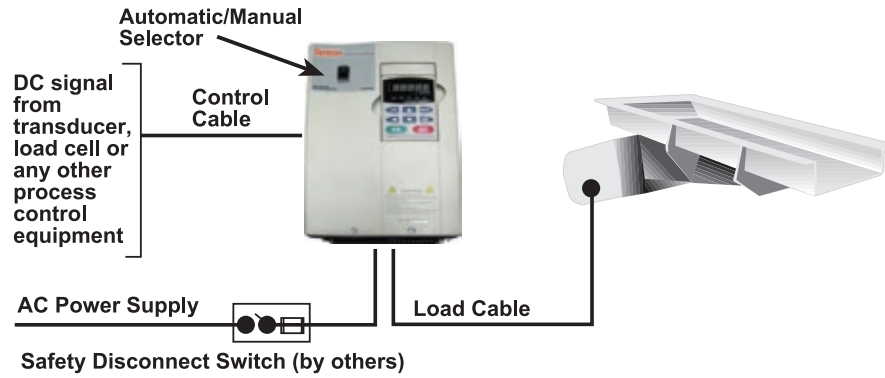

Electronic Control accepts a variable DC current or voltage signal from an external source and uses it to vary the feed rate.

Two-Rate Automatic Scale

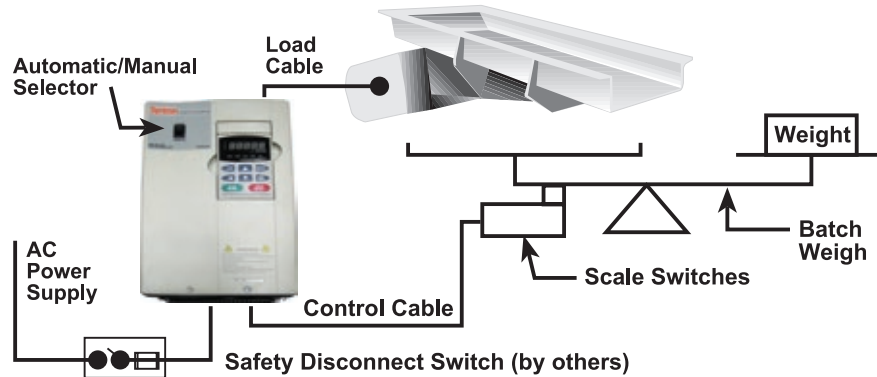

Perfect for batch weighing or bagging operations. External scale switches connected to control automatically signal primary fast material flow, secondary dribble flow, and instant shut-off at exactly the pre-selected weight. Primary and secondary setpoints are adjustable on keypad.

Load Monitoring Control

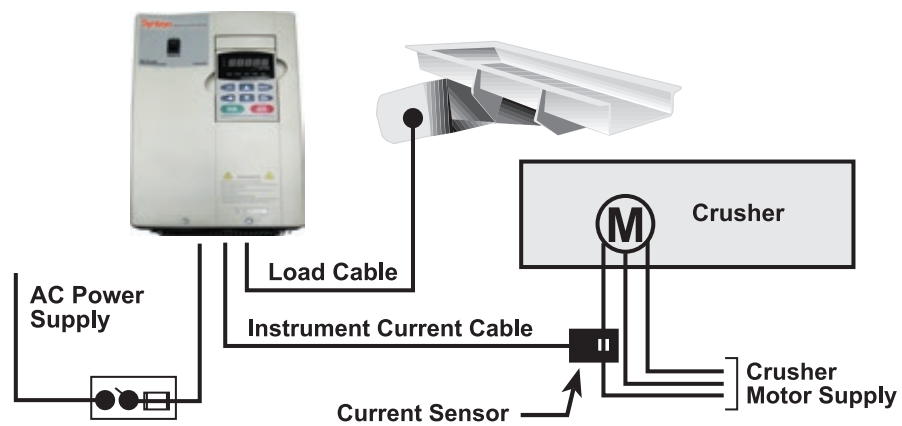

Sensor on electrical load of process equipment motors to determine when the machine is approaching an overload or underload condition connected to control which adjusts feeder output to correct machine loading.



Syntron® MF Electromechanical Feeders

MF Heavy-Duty Electromechanical Feeders

The high-capacity performers

Syntron® MF Heavy-Duty Electromechanical Feeders are the heavy-weights of bulk material handling and are used for higher capacity requirements. The ten heavy-duty models handle capacities from 600 to 4,000 tons per hour.*

Syntron® Heavy-Duty Electromechanical Feeders combine extra structural strength with durable components. The deep wing plates form a bridge between inlet and discharge suspension supports, providing extra strength for years of dependable service. Standard troughs feature unitized weldments – one-piece, completely welded units for greater strength. Troughs are also available with bolt-together construction for tunnel installations or other confined areas.

MF Heavy-Duty Electromechanical Feeders are two-mass, spring-connected and sub-resonant-tuned. The exciter unit is connected to the trough with corrosion resistant polymeric springs, which are more stable under varying conditions. The springs are compressed for improved load stability, improved feed angles and straight line motion. The spring design eliminates pinch points, an important safety feature.

All Syntron® MF Electromechanical Feeder motors are labeled for inverter duty and vibration service. Motors can be supplied to meet UL explosion-proof requirements.

* Based on sand weighing 100 pounds per cubic foot. Capacities vary depending on material characteristics, material density, trough length and width, trough liner type, feeder installation, skirt boards and hopper transitions.

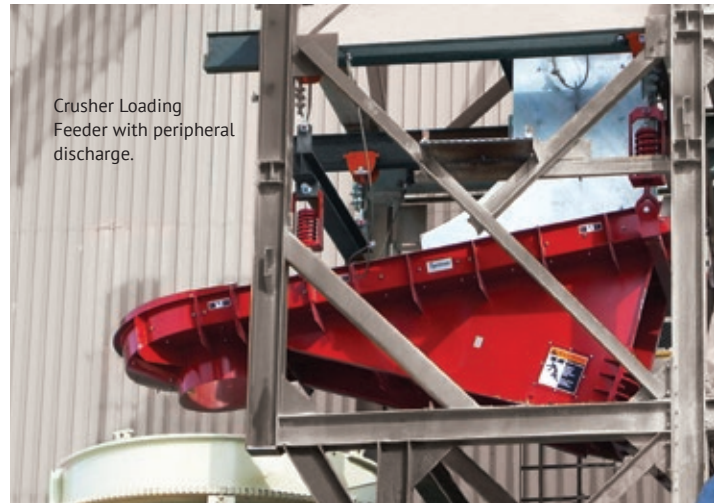

Crusher Loading Feeder with peripheral discharge.

NEW! Two-Mass Direct Drive

All MF Mechanical Feeders, except MF-1600 and 2000, are designed using the new Two-Mass Direct Drive. This drive provides reliable service using a rotary vibrator to minimize components. Belts and pulleys, which commonly require adjustment and replacement due to wear, are eliminated. The new Two-Mass Direct Drive is also maintenance friendly and requires minimal time for thrust adjustment or replacement.



Syntron® MF-200 Electromechanical Feeder feeding crushed stone in an aggregate operation.



Syntron® MF-600 Electromechanical Feeder feeding rock to a crusher.

MF Electromechanical Direct Drive Feeder Features

- Operating frequency - 1100 VPM at 55.4 Hz
- Stroke: 0.25 - 0.30 inches
- Dependable, flexible, easily adjustable
 - Minimal component design to reduce adjustments and replacements due to wear
 - Quick replacement of Drive Unit
 - Infinite unbalance adjustment
 - VFD control providing 10:1 turn-down feed adjustment
- Sub-resonant tuning
 - Stroke consistency and speed stability under varying headload and material dampening
- Start and operate fully loaded or empty
- Structural strength
 - Deep wing plates
 - Engineered weldments using the latest FEA techniques and software
- Hazardous Area Service
 - Explosion proof motors
 - ULXP:
 - Class 1, Div 1, Group C & D
 - Class 2, Div 1, Group E, F, & G
- Bolt-in trough liners
 - T1-A
 - AR-400, AR-500
 - 304 stainless steel
 - Chromium carbide overlay ceramic
 - UHMW, TIVAR, rubber

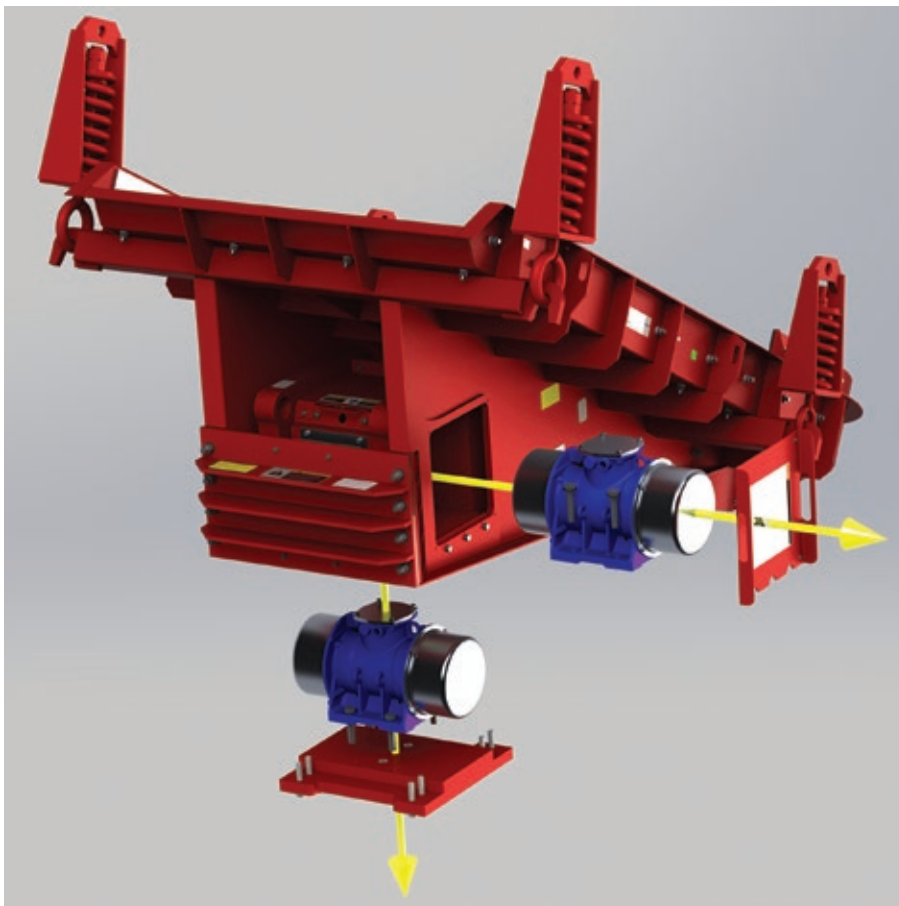

MF Heavy-Duty Feeder Specifications

MODEL MF-200-DD

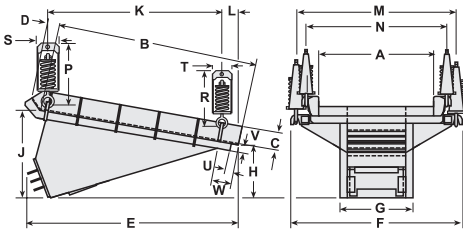

Please request a certified drawing for installation.

Approx. Trough W x L	Approx. Capacity tph	HP	KW	Approx. Current (460V)	Control Model	Net Wt. (lb)	Net Wt. (kg)	Approx. Ship Wt. (lbs) Feeder/Control	Approx. Ship Wt. (kg) Feeder/Control
36 x 72	600	4	3	4.4 amps	VF-5D2	2200	997	2800	1270
42 x 72	700	4	3	4.4 amps	VF-5D2	2400	1088	3000	1360
48 x 84	900	4	3	4.4 amps	VF-5D2	2500	1133	3100	1406
48 x 96	900	4	3	4.4 amps	VF-5D2	2600	1179	3200	1451
54 x 96	1000	4	3	4.4 amps	VF-5D2	2800	1270	3400	1542

◆ Based on feeder with 10° down slope, below-deck drive unit, installed with proper hopper transition and skirt board arrangement, feeding sand weighing 100 pounds per cubic foot. 460/575 Volt 60 Hz three-phase. 380/415 Volt 50 Hz three-phase.

	A	B	C	D	E	F	G	H	J	K	L	M	N	P	R	S	T	U	V	W
in	36	72	8	2 1/2	81 3/16	60 1/2	30	23 1/8	35 1/8	65 1/4	8 3/8	54	45 1/2	21 3/4	19	8	7 1/4	2	2	9 7/16
mm	914	1829	203	64	2062	1537	762	587	905	1657	213	1372	1156	552	483	203	184	51	51	240
in	42	72	8	4	81 1/4	65	30	23 1/8	35 1/8	64	3	60	51 1/2	21 3/4	19	8	7 1/4	4	3	4
mm	1066	1829	203	102	2064	1651	762	587	905	1626	76	1524	1308	552	483	203	184	102	76	104
in	48	84	8	4	87 1/8	72 1/2	30	22 1/16	36 11/16	71 1/4	6 13/16	66	57 1/2	25	21 3/4	9	8	-	3	7 13/16
mm	1219	2134	203	102	2213	1842	762	560	932	1810	173	1676	1461	635	552	229	203	-	76	198
in	48	96	8	4	93	72 1/2	30	21	37 3/4	76 1/4	10 7/8	66	57 1/2	25	21 3/4	9	8	2	2	12
mm	1219	2438	203	102	2362	1842	762	533	959	1937	276	1676	1461	635	552	229	203	51	51	305
in	54	96	8	4	93	77	30	21	34 3/4	74 7/8	12 1/8	72	72	21 3/4	21 3/4	8	8	2	2	10
mm	1372	2438	203	102	2362	1956	762	533	883	1902	308	1829	1829	552	552	203	203	51	51	25

Many other trough sizes are available. Capacities vary depending on drive unit location, material characteristics, material density, trough length and width, trough liner type, feeder installation, skirt boards and hopper transitions. Cad drawings are available. Please call Syntron Material Handling for expert help with your application.

MODEL MF-400-DD

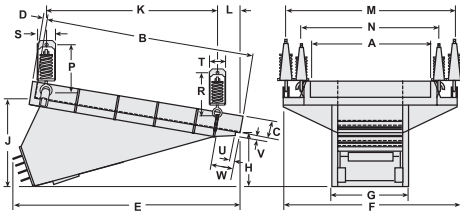

Please request a certified drawing for installation.

Approx. Trough W x L	Approx. Capacity tph ◆	HP	KW	Approx. Current (460V)	Control Model	Net Wt. (lb)	Net Wt. (kg)	Approx. Ship Wt. (lbs) Feeder/Control	Approx. Ship Wt. (kg) Feeder/Control
54 x 84	900	9	6.7	10.0 amps	VF-10D2	4500	2041	5200	2358
54 x 96	1000	9	6.7	10.0 amps	VF-10D2	4600	2086	5300	2404
60 x 84	1000	9	6.7	10.0 amps	VF-10D2	4600	2086	5300	2404
60 x 96	1200	9	6.7	10.0 amps	VF-10D2	4800	2177	5400	2449
66 x 96	1400	9	6.7	10.0 amps	VF-10D2	4900	2222	5600	2540
72 x 96	1600	9	6.7	10.0 amps	VF-10D2	5100	2313	5800	2630

◆ Based on feeder with 10° down slope, below-deck drive unit, installed with proper hopper transition and skirt board arrangement, feeding sand weighing 100 pounds per cubic foot. 460/575 Volt 60 Hz three-phase. 380/415 Volt 50 Hz three-phase.

	A	B	C	D	E	F	G	H	J	K	L	M	N	P	R	S	T	U	V	W
in	54	84	8	2 ½	105 1/16	80 ½	38	28 3/8	42 15/16	80	10 ¾	74	63 ½	26 ½	21 ¾	9	8	2	2	11 13/16
mm	1372	2134	203	64	2669	2045	965	721	1091	2032	273	1880	1613	673	552	229	203	51	51	300
in	54	96	8	2 ½	113 5/16	80 ½	38	28 3/16	44 13/16	85 5/16	10 ¾	74	63 ½	26	21 ¾	9	8	2	2	11 13/16
mm	1372	2438	203	64	2878	2045	965	716	1138	2167	273	1880	1613	660	552	229	203	51	51	300
in	60	84	8	2 ½	105 1/16	88 ½	38	28 3/8	42 15/16	80 ½	10 ¾	82	69 ½	26 ½	21 ¾	9	8	2	2	11 13/16
mm	1524	2134	203	64	2669	2248	965	721	1091	2045	273	2083	1765	673	552	229	203	51	51	300
in	60	96	8	8	113 5/16	90 ½	38	28 3/16	44 13/16	85 ¾	11 ¼	84	69 ½	26	21 ¾	9	8	2	2	12 5/16
mm	1524	2438	203	203	2878	2299	965	716	1138	2178	286	2134	1765	660	552	229	203	51	51	313
in	66	96	8	2 ½	113 5/16	96 ½	38	28 3/16	44 13/16	85 ¾	11 ¼	90	75 ½	26	21 ¾	9	8	2	2	12 5/16
mm	1676	2438	203	64	2878	2451	965	716	1138	2178	286	2286	1918	660	552	229	203	51	51	313
in	72	96	8	2 ½	114 ¾	98 ½	38	28 ¾	45 5/16	86 ½	11 ¼	92	81 ½	26	21 ¾	9	8	2	2	12 5/16
mm	1829	2438	203	64	2915	2502	965	729	1151	2197	286	2337	2070	660	552	229	203	51	51	313

MODEL MF-600-DD

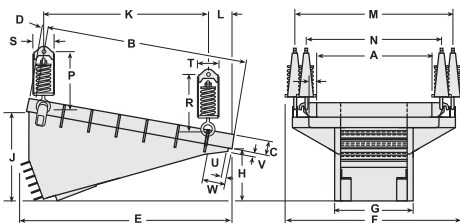

Please request a certified drawing for installation.

Approx. Trough W x L	Approx. Capacity tph ◆	HP	KW	Approx. Current (460V)	Control Model	Net Wt. (lb)	Net Wt. (kg)	Approx. Ship Wt. (lbs) Feeder/Control	Approx. Ship Wt. (kg) Feeder/Control
66 x 108	1600	15	11.2	19.4 amps	VF-15D2	8300	3764	9100	4127
72 x 96	1800	15	11.2	19.4 amps	VF-15D2	8100	3674	8900	4036

◆ Based on feeder with 10° down slope, below-deck drive unit, installed with proper hopper transition and skirt board arrangement, feeding sand weighing 100 pounds per cubic foot. 460/575 Volt 60 Hz three-phase. 380/415 Volt 50 Hz three-phase.

	A	B	C	D	E	F	G	H	J	K	L	M	N	P	R	S	T	U	V	W
in	66	108	8	8	120 1/8	99	45	30 1/8	48 7/8	94	13 5/8	90	81 1/8	32 ½	33 ¼	11 ¾	11 ¾	2	2	14 11/16
mm	1676	2743	203	203	3051	2515	1143	765	1241	2388	346	2286	2061	826	845	298	298	51	51	373
in	72	96	8	8	114 ¼	105	45	31 3/16	47 13/16	85 3/16	12 ¾	96	87 ½	32 ½	33 ¼	11 ¾	11 ¾	2	3	13 11/16
mm	1829	2438	203	203	2902	2667	1143	792	1214	2164	324	2438	2213	826	845	298	298	51	76	348

Many other trough sizes are available. Capacities vary depending on drive unit location, material characteristics, material density, trough length and width, trough liner type, feeder installation, skirt boards and hopper transitions. Cad drawings are available. Please call Syntron Material Handling for expert help with your application.

MF Heavy-Duty Feeder Specifications

MODEL MF-800-DD

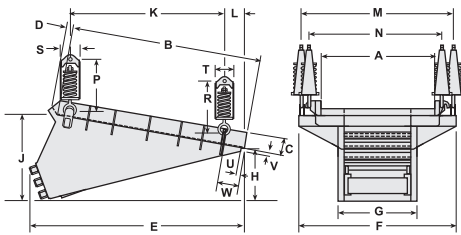

Approx. Trough W x L	Approx. Capacity tph ◆	HP	KW	Approx. Current (460V)	Control Model	Net Wt. (lb)	Net Wt. (kg)	Approx. Ship Wt. (lbs) Feeder/Control	Approx. Ship Wt. (kg) Feeder/Control
72 x 108	1800	15	11.2	19.4 amps	VF-20D2	11550	5238	12350	5601
84 x 108	2300	15	11.2	19.4 amps	VF-20D2	12350	5601	13150	5964

Please request a certified drawing for installation.

◆ Based on feeder with 10° down slope, below-deck drive unit, installed with proper hopper transition and skirt board arrangement, feeding sand weighing 100 pounds per cubic foot. 460/575 Volt 60 Hz three-phase. 380/415 Volt 50 Hz three-phase.

	A	B	C	D	E	F	G	H	J	K	L	M	N	P	R	S	T	U	V	W
in	72	108	10	8 ½	128 5/8	107	50	32 7/16	51 1/8	93 ¼	16 3/8	96	87 ¼	33 ¼	33 ¼	12 ½	11 ¾	3	3	17 5/8
mm	1829	2743	254	216	3267	2718	1270	824	1299	2369	416	2438	2216	845	845	318	296	76	76	448
in	84	108	8	8	128 5/8	117	45	31 11/16	51 1/8	94	16 5/8	108	99 1/8	32 ½	33 ¼	11 ¾	11 ¾	2	2	14 11/16
mm	2134	2743	203	203	3267	2972	1143	805	1299	2388	422	2743	2518	826	845	298	298	51	51	373

MODEL MF-1000-DD

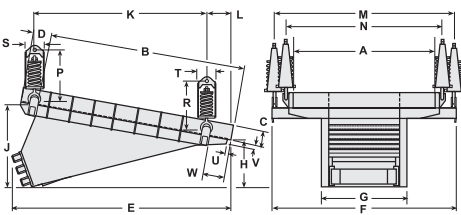

Approx. Trough W x L	Approx. Capacity tph ◆	HP	KW	Approx. Current (460V)	Control Model	Net Wt. (lb)	Net Wt. (kg)	Approx. Ship Wt. (lbs) Feeder/Control	Approx. Ship Wt. (kg) Feeder/Control
72 x 120	2000	20	14.92	21.8 amps	VF-25D2	13500	6123	14500	6577
84 x 132	2500	20	14.92	21.8 amps	VF-25D2	14000	6350	15000	6803

Please request a certified drawing for installation.

◆ Based on feeder with 10° down slope, below-deck drive unit, installed with proper hopper transition and skirt board arrangement, feeding sand weighing 100 pounds per cubic foot. 460/575 Volt 60 Hz three-phase. 380/415 Volt 50 Hz three-phase.

	A	B	C	D	E	F	G	H	J	K	L	M	N	P	R	S	T	U	V	W
in	72	120	10	10	143 7/16	109	58	33 ½	54 5/16	106 1/8	17 3/8	98	87 ¼	33 ¼	33 ¼	12 ½	11 ¾	3	3	18 ¾
mm	1829	3048	254	254	3643	2769	1473	851	1380	2696	441	2489	2216	845	845	318	298	76	76	476
in	84	132	10	10	149 3/8	121	58	32 7/16	55 3/8	116 1/2	16 5/8	110	110	33 ¼	32 ½	12 ½	11 ¾	3	3	15
mm	2134	3353	254	254	3794	3073	1473	824	1407	2959	422	2794	2794	845	826	318	298	76	76	381

Many other trough sizes are available. Capacities vary depending on drive unit location, material characteristics, material density, trough length and width, trough liner type, feeder installation, skirt boards and hopper transitions. Cad drawings are available. Please call Syntron Material Handling for expert help with your application.

MODEL MF-1600

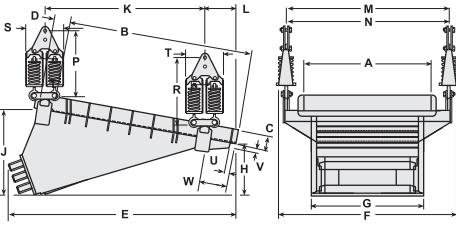

Approx. Trough W x L	Approx. Capacity tph	HP	Approx. Current (460V)	Control Model	Net Wt. (lb)	Net Wt. (kg)	Approx. Ship Wt. (lbs) Feeder/Control	Approx. Ship Wt. (kg) Feeder/Control
70 x 132	3200	30	35.0 amps	VF-30D2	19800	8981	21600	9797

◆ Based on feeder with 10° down slope, below-deck drive unit, installed with proper hopper transition and skirt board arrangement, feeding sand weighing 100 pounds per cubic foot. 460/575 Volt 60 Hz three-phase. 380/415 Volt 50 Hz three-phase.

Please request a certified drawing for installation.

	A	B	C	D	E	F	G	H	J	K	L	M	N	P	R	S	T	U	V	W
in	90	132	10	10	161 1/8	127	80	36 11/16	59 1/8	113 1/2	22 1/2	116	116	53	53	27	27	4	4	19 1/2
mm	2286	3353	254	254	4093	3226	2032	932	1514	2883	572	2946	2946	1346	1346	686	686	102	102	495

MODEL MF-2000

The largest Syntron® Electromechanical Feeder is the MF-2000. With a trough measuring 120 inches wide x 168 inches long, the MF-2000 has capacities up to 4,000 tph. Each one is custom built to meet demanding capacity requirements. Please contact Syntron Material Handling for dimensions.



A Syntron® MF-2000 Electromechanical Feeder measuring 72 inches wide by 240 inches long is custom built to feed coal at 1000 tph.

Many other trough sizes are available. Capacities vary depending on drive unit location, material characteristics, material density, trough length and width, trough liner type, feeder installation, skirt boards and hopper transitions. Cad drawings are available. Please call Syntron Material Handling for expert help with your application.

MF Heavy-Duty Feeder Trough Styles

All standard troughs are unitized welded construction and can be supplied in a variety of materials. Special coatings and liners are available, including abrasion-resistant steel, manganese, stainless steel, urethane, UHMW plastic, rubber overlay and ceramic tiles.



Flat Bottom Troughs are standard.

Optional above-deck drive units can be furnished for installations where there is insufficient space below the trough. Covers, down spouts and belt centering discharges can also be provided.

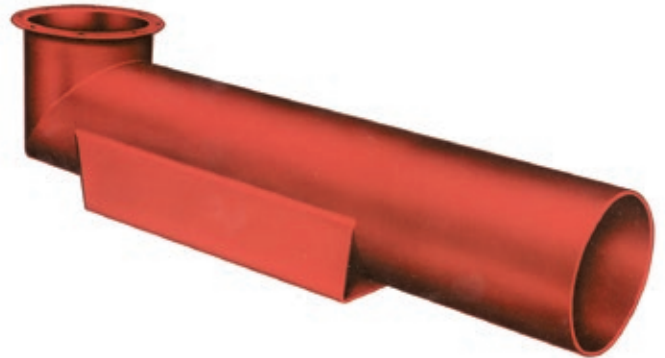

Tubular Troughs seal path of dusty materials.



Grizzly Bar Sections for scalping or coarse screening.

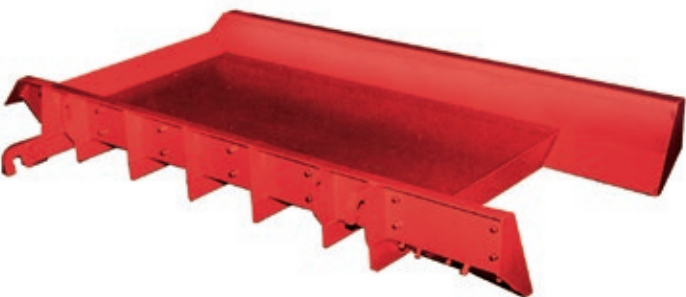

Belt Centering Discharge directs material on to a belt.

Other Trough Options Include:

- Covered Trough with Dust Seals
- Open Trough with Dust Seals
- Screening Feeders
- Diagonal Discharge Trough

Trough Liner Options Include:

- T-1A
- AR-400
- AR-500
- Stainless Steel
- Plastic
- Rubber
- Ceramic
- Carbide Overlay



Syntron® HP Electromechanical Feeders

HP High Performance Electromechanical Feeders

Lowering Project Cost While Boosting Productivity

Built with the Coal Industry in mind, our Syntron® quality products are synonymous with dependability and durability. We continue to listen to your needs and provide technology that is innovative, quality focused, and backed with the Syntron® value you demand and expect. With their robust two-mass, spring connected and sub-resonant tuned features, our feeders provide structural strength and durable components. This combination and the added feature of the deep wing plates forming a bridge between the inlet and discharge suspension supports make our Syntron® product the work horse in coal facilities around the globe.

What's different?

Trough to exciter relationship is key to feeder performance. This new exciter optimizes design fundamentals that are crucial when providing the highest performing feeders in the industry. Our methodology creates improved capacity and higher travel speeds in a more compact area, whereby lowering overall project cost. The exciter is connected to the trough with corrosion resistant polymeric springs, which are more stable under varying conditions. Our springs are compressed for improved load stability, and when combined with optimized motor placement, results in improved feed angles and straight line motion. The exciter is then properly balanced with many different trough options including bolt-together construction for ease of installation in tunnels and other confined areas.

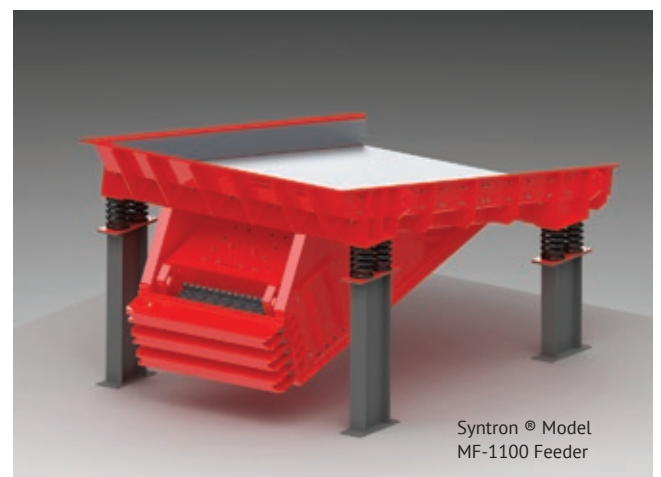
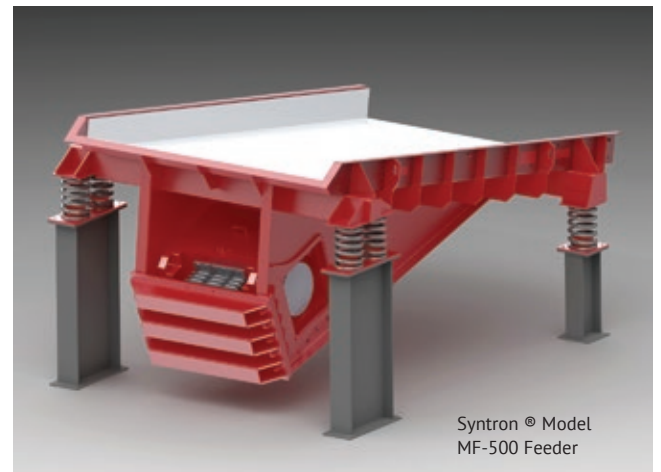
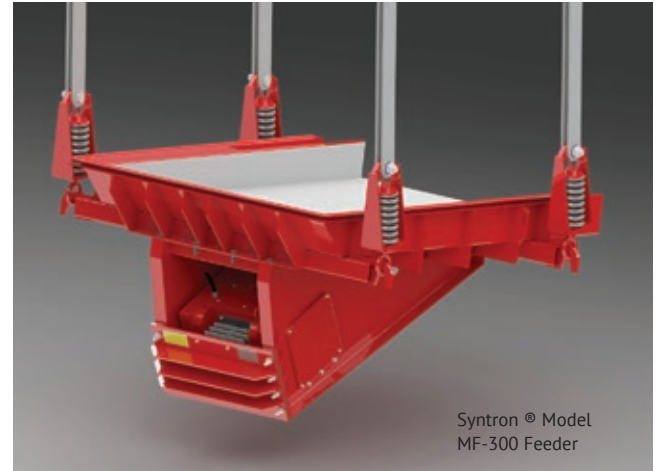



NEW! Two-Mass Direct Drive

Our three new feeder models – MF-300, MF-500 and MF-1100 – are made using the new Two-Mass Direct Drive. This drive provides reliable service using a rotary vibrator to minimize components. Belts and pulleys, which commonly require adjustment and replacement due to wear, are eliminated. The new Two-Mass Direct Drive is also maintenance friendly and requires minimal time for thrust adjustment or replacement.

Reduced Project Cost

Prep plants are currently increasing belt width to increase capacity, thus requiring larger feeders. Syntron Material Handling's new high performance feeders will provide the capacity needed *while minimizing*:

- Energy
- Space
- Initial feeder cost
- Size of prep plant structure
- Feeder trough size

HP Electromechanical Feeder Features

- Smaller feeder footprint, reducing initial construction and component cost
- Lighter weight for comparable capacity
- Lower energy consumption
- NEW! Two-Mass Direct Drive technology
- Added trough options such as:
 - One-piece stainless liner
 - Bolt-together troughs for confined areas

HP High Performance Feeder Specifications

MODEL MF-300-DD

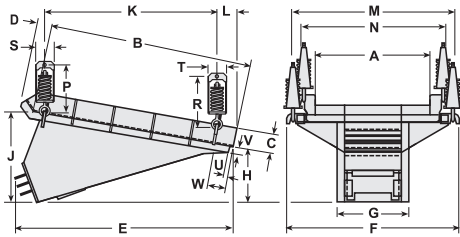

Approx. Trough W x L	Approx. Capacity tph ◆	HP	KW	Approx. Current (460V)	Control Model	Net Wt. (lb)	Net Wt. (kg)	Approx. Ship Wt. (lbs) Feeder/Control	Approx. Ship Wt. (kg) Feeder/Control
36 x 72	600	4	3	4.4 amps	VF-5D2	2300	1043	2900	1315
48 x 84	1000	4	3	4.4 amps	VF-5D2	2600	1179	3200	1451

Please request a certified drawing for installation.

◆ Based on feeder with 10° down slope, below-deck drive unit, installed with proper hopper transition and skirt board arrangement, feeding coal weighing 55 pounds per cubic foot. 460/575 Volt 60 Hz three-phase. 380/415 Volt 50 Hz three-phase.

	A	B	C	D	E	F	G	H	J	K	L	M	N	P	R	S	T	U	V	W
in	36	72	8	10 ⁹ / ₁₆	84	59	30	24 ¹ / ₁₆	36 ⁵ / ₈	65 ¹ / ₁₆	8 ³ / ₈	54	45 ½	21 ¾	19	8	7 ¼	2	2	9 7/ ₁₆
mm	914	1829	203	268	2134	1499	762	611	930	1653	213	1372	1156	552	483	203	184	51	51	240
in	48	84	8	8 5/ ₁₆	86 5/ ₁₆	71	30	36 ¾	37 ¹¹ / ₁₆	71 ³ / ₁₆	6 ¹³ / ₁₆	66	57 ½	21 ¾	21 ¾	8	8	1	2	7 ¹³ / ₁₆
mm	1219	2134	203	211	2192	1803	762	933	957	1808	173	1676	1461	552	552	203	203	25	76	198

MODEL MF-500-DD

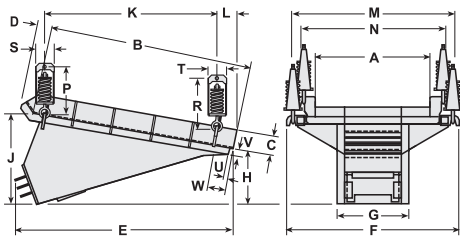

Approx. Trough W x L	Approx. Capacity tph ◆	HP	KW	Approx. Current (460V)	Control Model	Net Wt. (lb)	Net Wt. (kg)	Approx. Ship Wt. (lbs) Feeder/Control	Approx. Ship Wt. (kg) Feeder/Control
72 x 120	2300	9	6.7	10.0 amps	VF-10D2	7300	3311	7900	3583
72 x 126	2400	9	6.7	10.0 amps	VF-10D2	7400	3356	8000	3628

Please request a certified drawing for installation.

◆ Based on feeder with 10° down slope, below-deck drive unit, installed with proper hopper transition and skirt board arrangement, feeding coal weighing 55 pounds per cubic foot. 460/575 Volt 60 Hz three-phase. 380/415 Volt 50 Hz three-phase.

	A	B	C	D	E	F	G	H	J	K	L	M	N	P	R	S	T	U	V	W
in	72	120	8	4	131 ³ / ₄	97	38	27 ¹ / ₄	49 ¹ / ₈	102 ³ / ₄	13 ⁷ / ₁₆	91 ⁷ / ₁₆	82 ³ / ₁₆	31	20 ¹ / ₄	11 ³ / ₄	8	6	4	15 3/ ₁₆
mm	1829	3048	203	102	3346	2464	965	692	1248	2610	341	2323	2088	787	514	298	203	152	102	386
in	72	126	8	4	131 ³ / ₄	97	38	27 ¹ / ₂	49 ³ / ₈	102 ⁵ / ₈	14 ⁵ / ₁₆	91 ⁷ / ₁₆	82 ³ / ₁₆	31	20 ¹ / ₄	11 ³ / ₄	8	6	4	15 3/ ₁₆
mm	1829	3200	203	102	3346	2464	965	699	1254	2607	364	2323	2088	787	514	298	203	152	102	386

Many other trough sizes are available. Capacities vary depending on drive unit location, material characteristics, material density, trough length and width, trough liner type, feeder installation, skirt boards and hopper transitions. Cad drawings are available. Please call Syntron Material Handling for expert help with your application.

MODEL MF-1100-DD

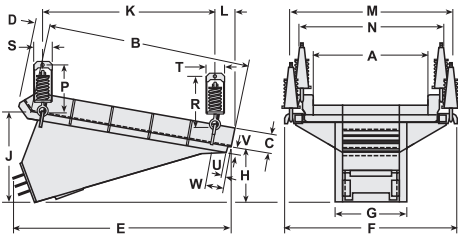

Approx. Trough W x L	Approx. Capacity tph	HP	KW	Approx. Current (460V)	Control Model	Net Wt. (lb)	Net Wt. (kg)	Approx. Ship Wt. (lbs) Feeder/Control	Approx. Ship Wt. (kg) Feeder/Control
96 x 144	3700	20	14.92	21.8 amps	VF-20D2	14800	6713	15500	7030
96 x 156	4100	20	14.92	21.8 amps	VF-20D2	15100	6849	16000	7257

Please request a certified drawing for installation.

◆ Based on feeder with 10° down slope, below-deck drive unit, installed with proper hopper transition and skirt board arrangement, feeding coal weighing 55 pounds per cubic foot. 460/575 Volt 60 Hz three-phase. 380/415 Volt 50 Hz three-phase.

	A	B	C	D	E	F	G	H	J	K	L	M	N	P	R	S	T	U	V	W
in	96	144	10	10	160 ³ / ₁₆	127 ¹ / ₈	56	33 ¹¹ / ₁₆	58 ⁷ / ₁₆	106 ¹³ / ₁₆	25 ¹ / ₈	122	111 ¹ / ₄	36	36 ¹ / ₄	12 ¹ / ₂	11 ³ / ₄	6 ¹ / ₄	4	27
mm	2438	3658	254	254	4069	3229	1422	856	1484	2713	638	3099	2826	914	921	318	298	159	102	686
in	96	156	10	10	163 ⁷ / ₈	127 ¹ / ₈	56	31 ⁵ / ₁₆	58 ⁷ / ₁₆	118 ⁵ / ₈	25 ¹ / ₈	122	111 ¹ / ₄	36	36 ¹ / ₄	12 ¹ / ₂	11 ³ / ₄	6 ¹ / ₄	4	27
mm	2438	3962	254	254	4162	3229	1422	795	1484	3013	638	3099	2826	914	921	318	298	159	102	686

Many other trough sizes are available. Capacities vary depending on drive unit location, material characteristics, material density, trough length and width, trough liner type, feeder installation, skirt boards and hopper transitions. Cad drawings are available. Please call Syntron Material Handling for expert help with your application.

SYNTRO-FLO Cone Crusher Loading Feeders by Syntron®

The SYNTRO-FLO Cone Crusher Loading Feeder by Syntron is a MF Two-Mass Tuned Direct Drive vibratory feeder with an engineered discharge uniquely designed for equal distribution of product. The trough including the discharge is fully lined to account for wear. Like traditionally designed feeders, it is suspension mounted, which can be easily integrated into a trolley system allowing it to be moved out of the way for crusher maintenance.

In side-by-side installations of a feeder-plus-rotary distributor versus a SYNTRO-FLO Cone Crusher Loading Feeder directly feeding the crusher, the SYNTRO-FLO unit delivered superior, cone-friendly performance. The uniform distribution provided by the SYNTRO-FLO unit increased crusher manganese life and yielded more cubicle formed product.

SYNTRO-FLO is available in 3 standard sizes for tertiary crusher applications: STF-3F, STF-4F and STF-5F. In addition, Syntron is developing the STF-3C, STF-4C and STF-5C for secondary crushing applications. Both designs work with 300 HP, 400 HP and 500 HP cones respectively. These designs will allow the SYNTRO-FLO unit to be the most cost effective solution feeding your Cone Crusher equipment. (See data sheet for equipment details). Syntron can build a custom cone crushing feeder unit for larger and smaller applications upon request.



Material Flow

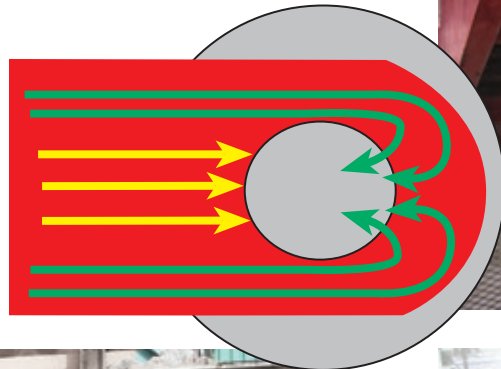

SYNTRO-FLO 3-F, 4-F and 5-F for Fine Crushing Applications

MODEL STF-3F, STF-4F, & STF-5F

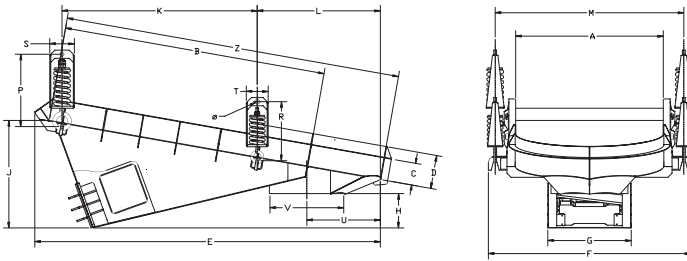

Please request a certified drawing for installation.

Model	Approx. Trough W x L	Approx. Capacity tph ◆	Max Particle Size (in)	HP	KW	Approx. Current (460V)	Control Model	Net Wt. (lb)	Net Wt. (kg)	Approx. Ship Wt. (lbs) Feeder/Control	Approx. Ship Wt. (kg) Feeder/Control
STF-3F	42 x 84	350	7	4	3	4.4	VF-5D2	3056	1390	3700	1700
STF-4F	48 x 90	440	8	4	3	4.4	VF-5D2	3725	1694	4325	1966
STF-5F	54 x 96	550	9	4	3	4.4	VF-5D2	3955	1798	4600	2090

◆ Based on feeder with 10° down slope, below-deck drive unit, installed with proper hopper transition and skirt board arrangement, feeding sand weighing 100 pounds per cubic foot. 460/575 Volt 60 Hz three-phase. 380/415 Volt 50 Hz three-phase.

	A	B	C	D	E	F	G	H	J	K	L	M	P	R	S	T	U	V	Z	Ø
in	42.00	84.00	8.00	12.00	108.68	63.50	30.00	13.78	38.13	62.00	36.88	57.00	21.75	19.00	8.00	7.25	20.81	21.00	105.00	1.03
mm	1066.80	2133.60	203.20	304.80	2760.47	1612.90	762.00	350.01	968.38	1574.80	936.63	1447.80	552.45	482.60	203.20	184.15	528.57	533.40	2667.00	26.19
in	48.00	90.00	8.00	12.00	117.56	69.50	30.00	12.55	38.69	67.00	40.81	63.00	26.50	21.75	9.00	8.00	23.56	24.00	114.00	1.03
mm	1219.20	2286.00	203.20	304.80	2986.02	1765.30	762.00	318.77	982.66	1701.80	1036.64	1600.20	673.10	552.45	228.60	203.20	598.42	609.60	2895.60	26.19
in	54.00	96.00	8.00	12.00	126.39	75.50	30.00	12.55	39.19	71.38	45.25	69.00	26.25	21.75	9.00	8.00	26.88	27.00	123.00	1.31
mm	1371.60	2438.40	203.20	304.80	3210.31	1917.70	762.00	318.77	995.36	1812.93	1149.35	1752.60	666.75	552.45	228.60	203.20	682.75	685.80	3124.20	33.34

Syntron® Electromechanical Feeder Controls

State-of-the-art, solid-state units that can vary material flow rate

Controls for electromechanical feeders are VF Series (variable frequency VFD-type) and are optimized for efficient operation, and allow for a full range of material flow with a 10:1 turn-down ratio.

VF Series Control



The VF Series controls are UL/CUL approved. In addition, a wide range of optional functions are available for specific control requirements:

- analog input
- digital communication
- onboard diagnostic capability

Electromechanical Feeder Control Configuration

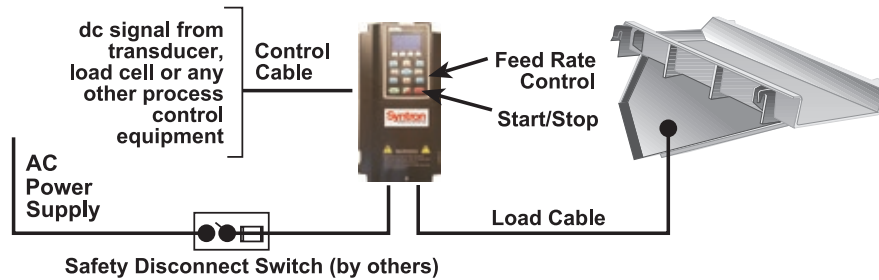

Variable-frequency controls offer total feed rate regulation through manual adjustment or PLC interface.

Electromechanical Feeder Control Dimensions

Digital Keypad

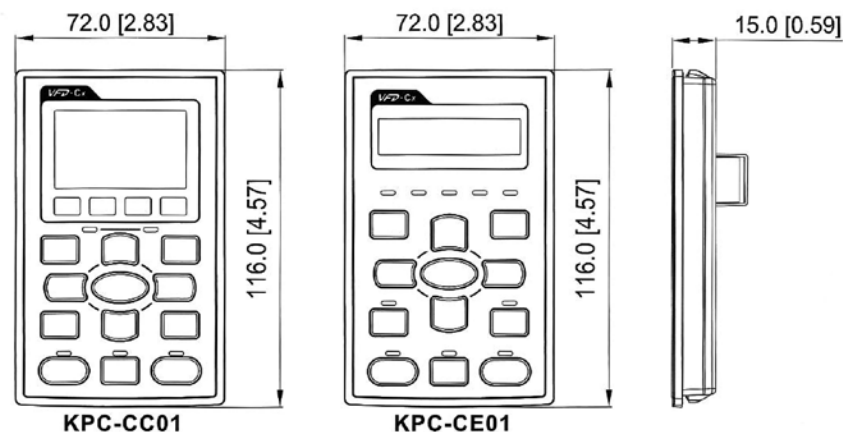

Electromechanical Feeder Control Dimensions

Frame A

MODEL
VF-5D2

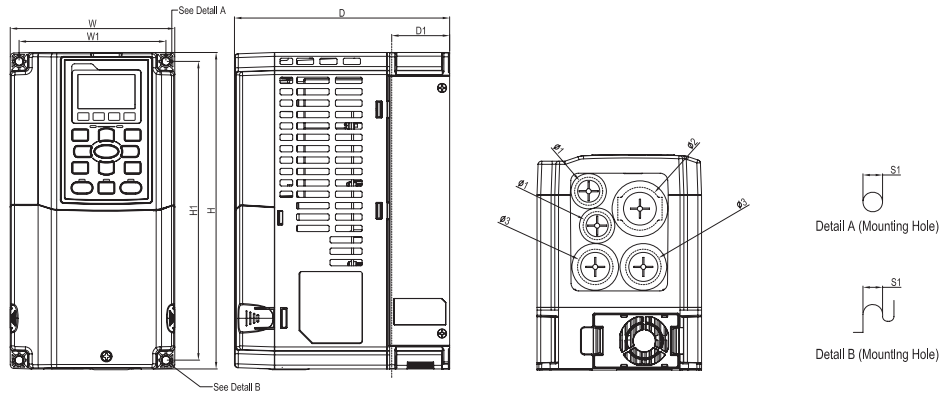

Unit: mm [inch]

Frame		W	H	D	W1	H1	D1*	Ø	Ø1	Ø2	Ø3
A1	mm	130.0	250.0	170.0	116.0	236.0	45.8	6.2	22.2	34.0	28.0
	inch	5.12	9.84	6.69	4.57	9.29	1.80	0.24	0.87	1.34	1.10

D1*: Flange Mounting

Frame B

MODEL
VF-10D2
VF-15D2
VF-20D2

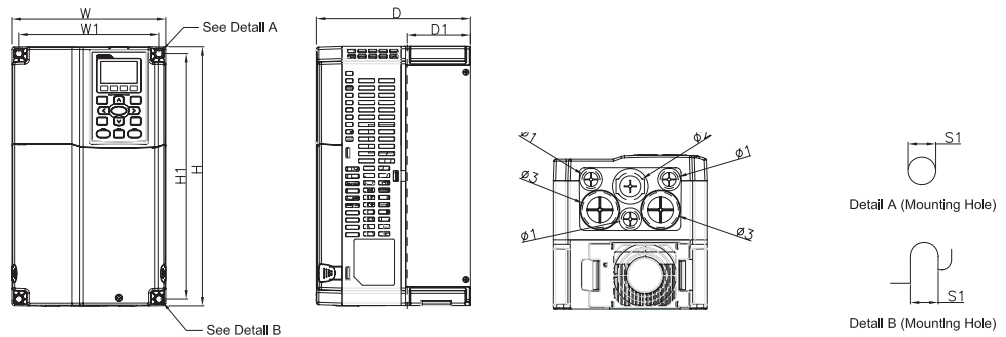

Unit: mm [inch]

Frame		W	H	D	W1	H1	D1*	Ø	Ø1	Ø2	Ø3
B1	mm	190.0	320.0	190.0	173.0	303.0	77.9	8.5	22.2	34.0	28.0
	inch	7.48	12.60	7.48	6.81	11.93	3.07	0.33	0.87	1.34	1.10

D1*: Flange Mounting

Frame C

MODEL
VF-25D2
VF-30D2
VF-40D2

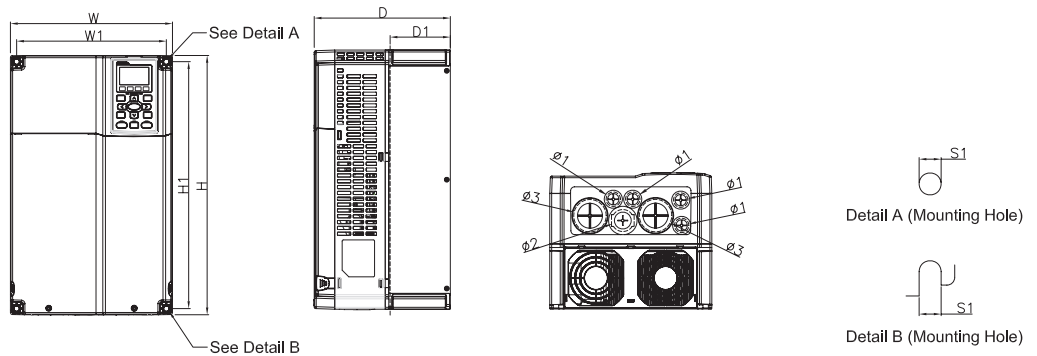

Unit: mm [inch]

Frame		W	H	D	W1	H1	D1*	Ø	Ø1	Ø2	Ø3
C1	mm	250.0	400.0	210.0	231.0	381.0	92.9	8.5	22.2	34.0	50.0
	inch	9.84	15.75	8.27	9.09	15.00	3.66	0.33	0.87	1.34	1.97

D1*: Flange Mounting

Recommended Designs for Hoppers and Transitions

Feeder Transition Hoppers

Feeder capacity depends on the design of the hopper. Material characteristics such as size distribution, shear properties and cohesiveness generally dictate the configuration of feeder transition hoppers. Material flow velocities vary, depending upon material properties, feeder stroke and operating speed.

Good transition hopper design optimizes flow rate, resulting in the most economical choice of a feeder. Improperly designed transition hoppers will substantially reduce feeder capacities.

Figure 1 illustrates Ideal and Acceptable Hopper designs. The Ideal Hopper with a throat (T) to gate height (H) ratio of 0.6 shows a uniform material flow pattern to the feeder trough. Material at the front and rear of the hopper moves at nearly the same velocity, and the discharge depth (d) is nearly equal to the hopper gate height. The Ideal Hopper design allows the most economical feeder to be used.

The Acceptable Hopper design may require a slightly larger feeder than required for the Ideal Hopper design. This is due to the non-uniform flow pattern of material at the rear of the hopper. Material flow velocity is reduced, material depth “d” is reduced and there is a reduction in feeder capacity. A T/H ratio of 0.6 to 1.0 is generally acceptable. However, when the T/H ratio exceeds this range, the material flow patterns distort drastically and will significantly reduce capacities.

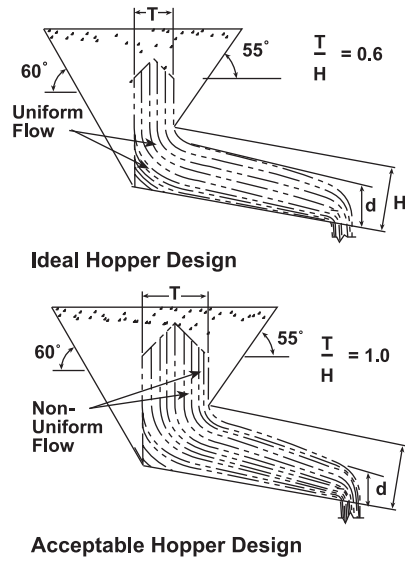

Figure 1. Hopper Design

T = Throat	GF = Gate Factor
H = Gate Height Opening	R = Flow Rate (ft/min)
C = Capacity	◆ See Chart
d = Depth of Flow at Discharge	W = Feeder Width (inches)

$$d \text{ (in)} = \frac{\text{Capacity (tons per hour)} \times 4800}{[W \text{ (in)} - 4 \text{ (in)}] \times R \text{ (ft/min)} \times D \text{ (lb/ft}^3\text{)}}$$

$$C \text{ (tph)} = \frac{[W \text{ (in)} - 4 \text{ (in)}] \times R \text{ (ft/min)} \times D \text{ (lb/ft}^3\text{)} \times d \text{ (in)}}{4800}$$

◆ Flow Rate - R (ft/min)

Suggested Electromagnetic Size

- If material size is -4 in with a trough down slope of up to 10°, use 50-60 ft/min.
- If material size is +4 in to -12 in with a trough down slope of up to 10°, use 45-55 ft/min.
- If material size is +12 in with a trough down slope of up to 10°, use 40-50 ft/min.

Suggested Electromechanical Size

- If material size is -4 in with a trough down slope of up to 10°, use 50-60 ft/min.
- If material size is +4 in to -12 in with a trough down slope of up to 10°, use 45-55 ft/min.
- If material size is +12 in with a trough down slope of up to 10°, use 40-50 ft/min.

Feeder down slope usually effects flow rate by 2% per degree. As down slope increases flow rate increases. As down slope decreases flow rate decreases.

Ideal Hopper Promotes:

- Uniform flow pattern
- Maximum capacity
- Maximum material velocity
- Maximum material depth
- Optimized feeder size
- Reduced potential for material buildup at inlet
- Reduced potential for spillage at back and sides
- Reduced material load on feeder

Recommended Hopper Design and Feeder Selection

Refer to Figure 2.

1. Rear wall angle steep enough to permit material flow ($60^\circ \pm 5^\circ$).
2. Front wall angle just enough to permit material flow ($55^\circ \pm 5^\circ$).
3. The throat dimension "T" for random size material should be a minimum of 2 times the largest particle size. For particles that are nearly the same size (near size), "T" should be a minimum of 4 times the largest particle size to prevent blockage at the throat opening. In all cases, the arc "A" should exceed $2\frac{1}{2}$ times the largest particle size.
4. Gate opening "H" must be a minimum of 2 times the largest particle of material and should increase proportionally for the desired capacity. The most economical feeder is selected when the throat dimension "T" is equal to or slightly larger than $H/2$. If "T" is greater than "H" the flow pattern of the material is disturbed, resulting in non-uniform flow.
5. When adjustable gates are used, the gate must be parallel to the hopper's front wall and must be as close to the front wall as possible. The separation must not exceed 2 inches. The gate should act as an adjustable front wall. Leveling blades and down stream gates must not be used. Horizontal cut off gates should be used to perform feeder maintenance and must not be used to regulate flow.

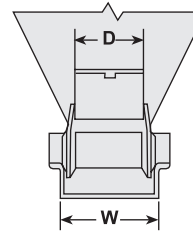
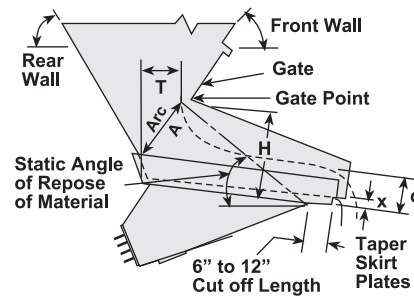

6. The inside width of the opening "D" (between stationary skirtboards) should allow for a 1-inch clearance between the feeder trough and skirt boards and should be a minimum of $2\frac{1}{2}$ times the largest particle size. For near size material the width of "D" should be a minimum of 4 times the largest particle size.
7. The minimum length of the feeder is determined by projecting the angle of repose for the specific material from the gate point to the feeder pan and adding approximately 6 inches.
8. The feeder must not contact any adjacent structure but must be free to vibrate. Allowance must be made for a decrease in feeder elevation of approximately 2 inches, due to static material load. In addition, 1 inch minimum clearance at sides and $1\frac{1}{2}$ inches at bottom and back must be maintained in both loaded and unloaded conditions.
9. The skirts must taper in the direction of flow (diverge from conveying surface) to prevent material from jamming and causing additional problems such as spillage and build-up. Skirts must run parallel to trough sides and must be reinforced to resist bulging outward against trough.

Syntron Material Handling offers free review and advice on your hopper and Syntron® feeder installation and isolation. Just send us your layout drawings.

Feeder Mounting and Isolation

Base Mounting

Base-mounted vibratory equipment sits directly on isolation springs mounted on seats which attach to the stationary support structure made by others. The springs can be steel coil, polymeric or pneumatic.

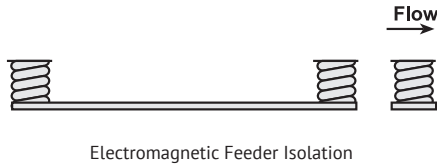

Electromagnetic Feeder Isolation

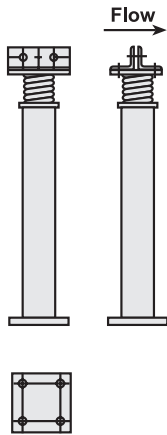

Electromagnetic Trough Post

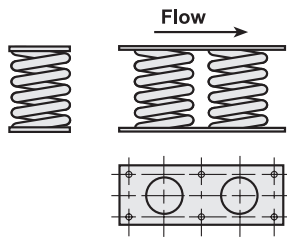

Electromechanical Dual Spring Isolation

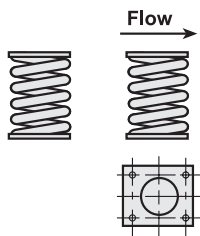

Electromechanical Single Spring Isolation

Suspension Mounting

Suspension-mounted vibratory equipment hangs from isolation assemblies attached to the overhead stationary support structure made by others.

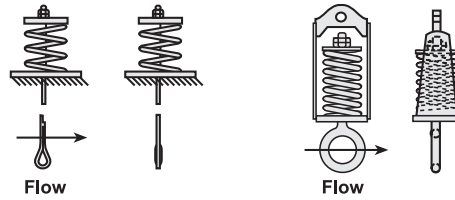

RF Feeder Hanger

MF Feeder Hanger

Electromechanical Feeder Hangers

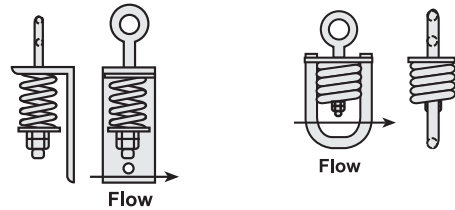

Angle Hanger

Bail Hanger

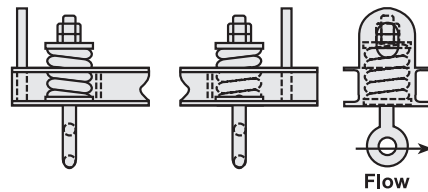

Beam Hanger

Electromagnetic Feeder Hangers

Syntron Material Handling does not recommend the use of turnbuckles or rods when mounting vibratory equipment.

Safety cables are recommended on all suspension-mounted vibratory equipment.

Syntron Material Handling recommends the use of flexible wire rope for suspension-mounted vibratory equipment. A chart of the proper wire rope sizes is available on our website, www.syntronmh.com, in our free book "Working with Isolation" and in our Service Instruction Manuals which accompany the shipment of equipment.

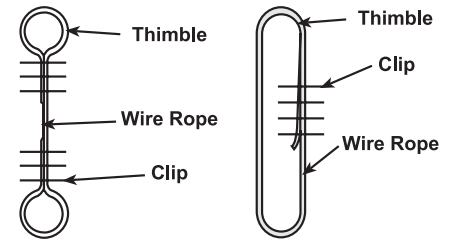

Wire Rope Diagram

Syntron Material Handling suggests the use of link bar assemblies when a wire rope suspension is too short to be assembled in accordance with wire rope manufacturer recommendations. Contact Syntron Material Handling for appropriate link bar dimensions for specific applications.

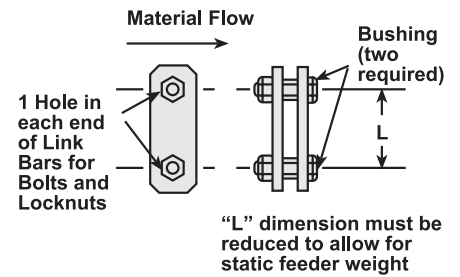

Link Bar Assembly

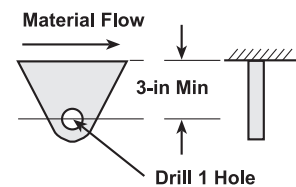

Mounting Lug for Wire Rope or Link Bar Isolation

Syntron® Vibrators

Syntron® Vibrators offer an efficient, cost-effective means to maintain free flow of product from bins, hoppers and chutes, with a direct and positive result on the bottom line. Whether the need is to ensure constant, uninterrupted material flow, or to eliminate the necessity for manual manipulation of a bin, hopper or bulk material, Syntron® Vibrators increase productivity and reduce production costs.

Three types of Syntron® Vibrators – electromagnetic, rotary electric and pneumatic – provide product flow solutions for just about any industry, application or environment. Compact yet mighty, Syntron® Vibrators are designed for years of high-performance, trouble-free continuous or intermittent operation, with the broadest selection of models and power ranges available.

Syntron® Electromagnetic Vibrators are ideal for continuous or intermittent operation. An easily adjustable control assures optimum and variable material flow. Dependable Syntron® Electromagnetic Vibrators are virtually maintenance-free because the electromagnetic design eliminates moving parts. Most models come standard with fully-enclosed dust-tight and watertight construction.

Syntron® Electric Rotary Vibrators are motor driven for reduced noise levels. These rugged vibrators are totally enclosed for reliable operation in dusty, dirty or moist environments. Adjustable eccentric weights allow easy adjustment of force to suit varying applications.

Syntron® Pneumatic Vibrators can be installed where electricity is not readily available because they use compressed air. Two types of pneumatic vibrators, turbine and piston, are available. Designed to keep operating noise at a minimum, Syntron® Pneumatic Turbine Vibrators are ideal for locations where noise pollution is undesirable. Vibrator speed is adjusted by simply varying the air supply. Pneumatic turbine vibrators feature totally enclosed construction which eliminates concern over environmental factors such as dust, dirt or moisture.



Syntron® Electromagnetic Vibrators

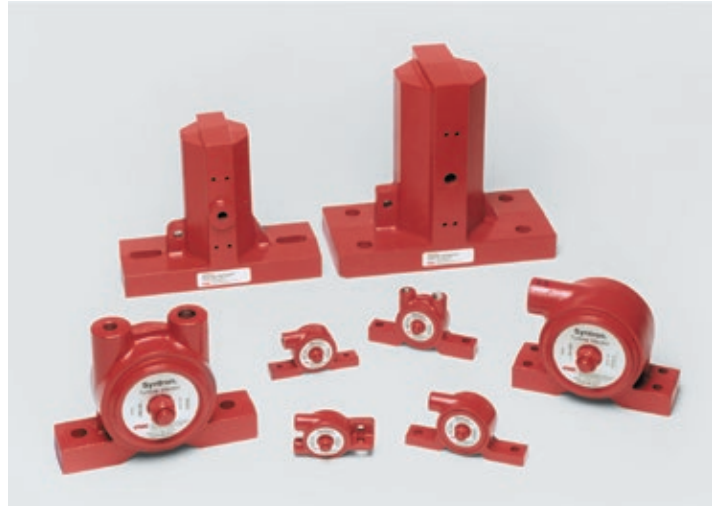

Syntron® Pneumatic Vibrators

VIBRATOR DATA SHEET

Supplement this data sheet with additional comments and/or drawings that will assist in a complete description of the application.						
Material to be Handled	Name or Description	Samples being Furnished <input type="checkbox"/> Yes <input type="checkbox"/> To be Returned <input type="checkbox"/> No <input type="checkbox"/> To be Destroyed				
Maximum Weight in Bin or Hopper _____ LBS.	Tendency to <input type="checkbox"/> Arch <input type="checkbox"/> Rathole	Fineness (Attach screen analysis, if possible)	Weight _____ lbs. Per cubic ft.	Moisture Content _____ %	Temperature _____ °F	
Bin or Hopper	Location of Inlet Opening		Angle of Bottom _____ ° From Horizontal		Discharge <input type="checkbox"/> Intermittently <input type="checkbox"/> Continuously	
Size of Bin or Hopper Diameter _____ Length _____ Width _____ Depth _____			Size of Discharge Opening Diameter _____ Length _____ Width _____			

Add dimensional information. Also show reinforcing, if any, and number and location of discharge opening. Use the reverse side for sketches if necessary.

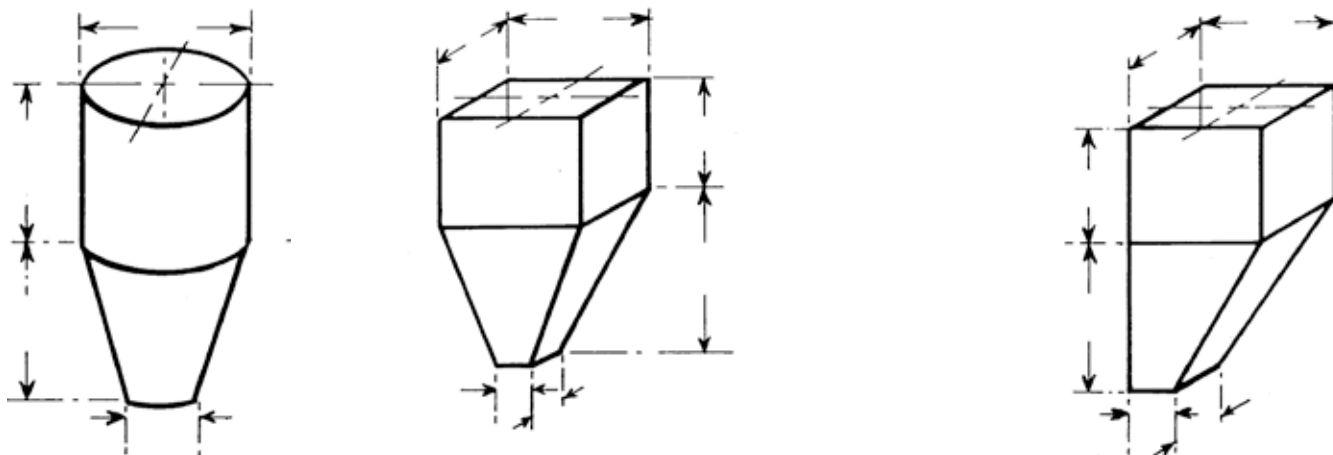

Bin or Hopper Construction <input type="checkbox"/> Steel: _____ Gauge <input type="checkbox"/> Welded <input type="checkbox"/> Riveted			<input type="checkbox"/> Wood: <input type="checkbox"/> Plank _____ Inches <input type="checkbox"/> Metal Liner <input type="checkbox"/> Plywood _____ Thick _____ Gauge		
Special Requirements _____					
Unit Preference Impacting: <input type="checkbox"/> Electromagnetic (solid <input type="checkbox"/> / Cushioned <input type="checkbox"/>) <input type="checkbox"/> Pneumatic Piston (solid <input type="checkbox"/> / Cushioned <input type="checkbox"/>) Inertial <input type="checkbox"/> Electromechanical <input type="checkbox"/> Pneumatic Turbine			Volts _____ Cycles _____ Phases _____		
Customer Name		Quote To Attention Of		Phone	
Street		Contract Engineer		Syntron Representative	
City	State	Zip Code	Mail Quote To: <input type="checkbox"/> Customer <input type="checkbox"/> Sales Office		Date

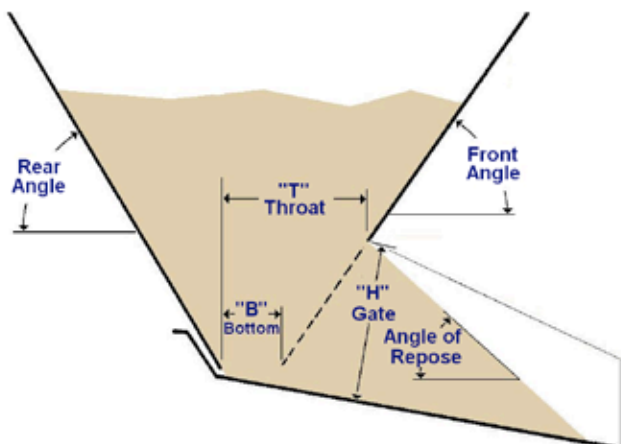
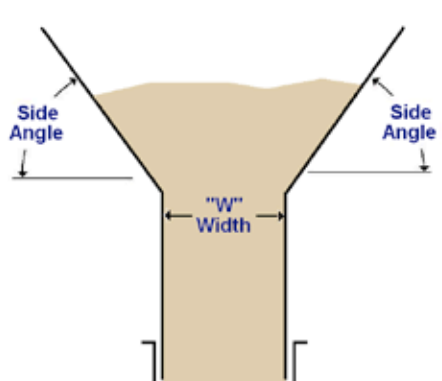
Quantity of Feeders:		Name or description of material to be handled:			
Weight (lbs.) per Cubic Foot ____ PCF	Size of Material (Sieve Analysis)	Material Width ____ Max: ____	Material Length ____ Max: ____	Material Thickness ____	Temperature of Material ____ F deg. Max Temperature of Surroundings ____ F deg. Max
Moisture Content: ____ %	Angle of Repose ____ deg.	Minimum feed rate (in tons per hour) ____ TPH		Maximum feed rate (in tons per hour) ____ TPH	
Trough Type: (Sketch if other than flat open pan) <input type="checkbox"/> Flat Open Pan <input type="checkbox"/> Covered <input type="checkbox"/> Tubular <input type="checkbox"/> Down Spout <input type="checkbox"/> Belt Loader <input type="checkbox"/> Diag. Disc				Dimensions Requested ____ " Wide X ____ " Long X ____ " High <input type="checkbox"/> None Requested (Provide most economical)	
Trough Liners: <input type="checkbox"/> T1-A <input type="checkbox"/> 304SS <input type="checkbox"/> UHMW <input type="checkbox"/> Other ____		Trough Slope: ____ deg. down ____ deg. up.		Type of Mounting: <input type="checkbox"/> Base <input type="checkbox"/> Suspension	Drive Position: <input type="checkbox"/> Under trough in rear <input type="checkbox"/> Over trough in front
Controller Enclosure: <input type="checkbox"/> Standard (NEMA+) <input type="checkbox"/> D.C. Input <input type="checkbox"/> Load Monitoring <input type="checkbox"/> Proportional <input type="checkbox"/> Remote Pot If there are any additional controller requirements please describe:				AC (Municipal) Power: ____ Voltage ____ Cycle ____ Hz	
Method of supplying material to Syntron Feeder trough:					
Feeder discharges into:					
If an existing hopper, provide dimensions and wall slope. Provide additional sketch if necessary.					
<p>Hopper Transition:</p> <p>"T" = ____ "H" = ____ "B" = ____ Rear Angle = ____ Front Angle = ____ "W" = ____ Side Angle = ____</p> <div style="display: flex; justify-content: space-around;">   </div>					
If there are any unusual operating conditions requiring special construction, please give details.					
Customer Type: <input type="checkbox"/> User <input type="checkbox"/> OEM <input type="checkbox"/> Resale		Contact: Address: City, State, Zip:		Email: Phone: Fax:	
Company Name:					

Syntron Material Handling

Corporate Office

P.O. Box 1370

Tupelo, Mississippi 38802

Phone: 662.869.5711

Fax: 662.869.7449

Proven Engineered Products – Complete Material Handling Solutions

Syntron®

Link-Belt®

Saltillo

2730 Hwy 145 South

Saltillo, Mississippi 38866

Phone: 662.869.5711

Fax: 662.869.7493

Toll Free: 800.356.4898

info@syntronmh.com

Changshu

#2 Road No. 1

Changshu Export Processing Zone

Changshu, Jiangsu, China 215513

Phone: +86 0512.52299002

Fax: +86 0512.52297228

info@syntronmh.com