

**Link-Belt®
Bucket Elevators
and Buckets**

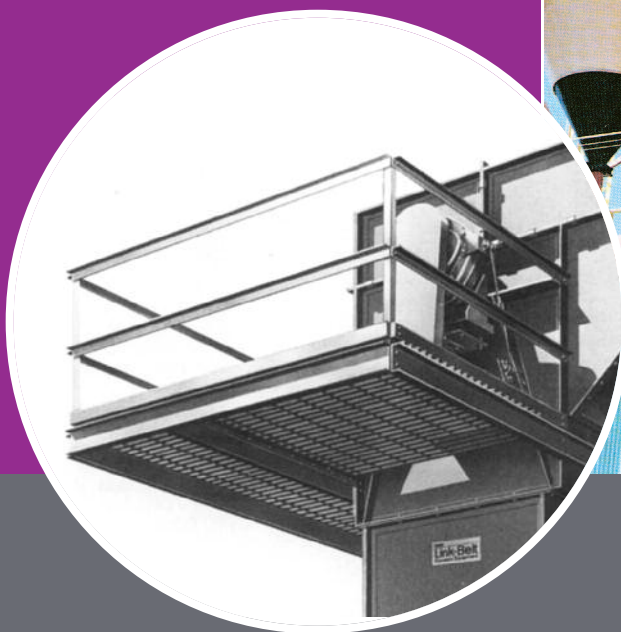
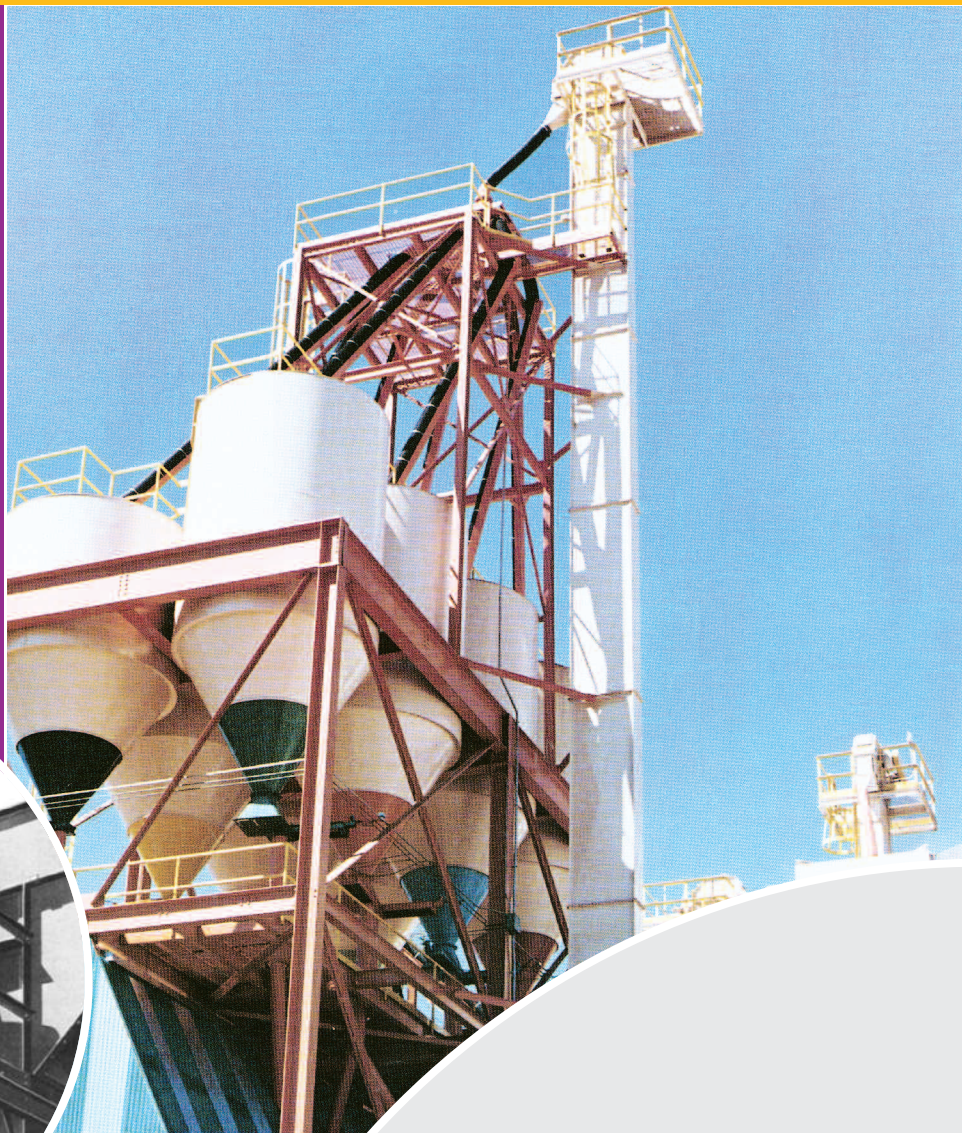

Table of Contents

Bucket Elevators

Link-Belt® Bucket Elevators	5
Standardization - the Key to Economical Design	6
Selection Procedure for Standard Bucket Elevators, Types 1 and 7	7
Typical Bulk Materials Handled by Bucket Elevators	8
Link-Belt® Bucket Elevators, Type 1	9
Selection / Specifications Type 1 - Chain	10
Selection / Specifications Type 1 - Belt	12
Dimensions Type 1 Chain or Belt	14
Link-Belt® Bucket Elevators, Type 7	15
Selection / Specifications Type 7 - Chain	16
Dimensions Type 7 Chain	18
Service Platforms	19
Standard Components	20
Other Bucket Elevator Models Available	21

Elevator Buckets

Link-Belt® Elevator Buckets	22
Elevator Bucket Types	22
Elevator Bolts	26
Bucket Punching for Chains	27
Centrifugal Discharge Elevator Buckets on K Attachments	27
Continuous Elevator Buckets on K Attachments	29
Super Capacity Continuous Elevator Buckets on G Attachments	30
Type AA Centrifugal Discharge Elevator Buckets on G Attachments	30
Types AA and SC Centrifugal Discharge Elevator Buckets on A and B Wing Attachments	31
Types AA, AA-RB and SC Centrifugal Discharge Elevator Buckets	32
Types HF, HFO, MF and LF Continuous Elevator Buckets	32



Syntron Material Handling

Proven Engineered Products – Complete Material Handling Solutions

Two powerful industry leading brands—**Link-Belt®** and **Syntron®**—have come together under a new company name, Syntron Material Handling, LLC, for one goal – better engineered products.

Established in May 2014, Syntron Material Handling (SMH) was built out of the legacies of Link-Belt® Company and Syntron Company, formerly owned by FMC Technologies. Today, our 300 skilled employees have a combined 4,212 years of industry knowledge that they put into the SMH product every day. We are dedicated to providing customers with complete material handling solutions.

Let Syntron Material Handling's knowledgeable team help your business with conveying, feeding, screening, elevating, vibratory flow aids, and mining controls of bulk product. Whether optimizing existing systems or starting from the ground-up on new and customized plants or mines, our dedicated staff will provide you with the most efficient and cost-effective solutions.

"Our company structure will be very exciting and fast-paced as we charter our new path. The positive attitudes and skills of our employees, the strength of our products, and our long-term customer relationships are our foundation for success." said CEO Andy Blanchard.

An international leader for innovative solutions, Syntron Material Handling can improve the technology customers are already using. The Link-Belt® expertise and equipment have been instrumental in developing some of the world's largest belt conveyors. The Syntron® feeders are instrumental to supplying energy sources and material handling efforts across the globe.

Levine Leichtman Capital Partners, the new owner of Syntron Material Handling, is committed to the success and growth of the company by investing in engineering capabilities, manufacturing efficiency, and customer service.

Although we may have a new name, we still have the same dedicated employees and industry leading engineered products that make us a market leader.

Syntron Material Handling operates two manufacturing facilities in the USA and China.

All of our products are produced to OSHA/MSHA standards and ISO Standard 9001:2008. We are a charter member of CEMA, and active members of NSSGA, NMA, SME, FEMA, PTDA, and PMMI.



Call us today for all your material handling needs.

Saltillo
2730 Hwy 145 South
Saltillo, Mississippi 38866
Phone: 662.869.5711
Fax: 662.869.7493
800.356.4898
orders@syntronmh.com

Changshu
#2 Road No. 1
Changshu Export Processing Zone
Changshu, Jiangsu, China 215513
Phone: +86 0512.52299002
Fax: +86 0512.52297228

Link-Belt® Bucket Elevators designed and manufactured to provide years of dependable and efficient service.

Link-Belt® Bucket Elevators, manufactured by Syntron Material Handling, have long been the industry standard for any bulk material elevating application. Service-proven performance under the most demanding operating conditions in thousands of installations from rural grain elevators to large manufacturing and processing plants... the result of over 100 years experience as an engineering pioneer and leading manufacturer.

A Link-Belt® designed Bucket Elevator is your assurance of quality and dependability, and the standard Type 1 and Type 7 Syntron Material Handling Bucket Elevators have many outstanding features:

- Standardization of designs that are dependable and versatile.

- Continuous or centrifugal type discharge.
- Rigid, strong, jig-built casings in perfect alignment and weather-tight.
- Two-piece hood permitting access to head section interior without disturbing machinery. Spring clamps facilitate removal and replacement.
- Inspection hatch that can be easily lifted to view terminal machinery.
- Optional shaft mounted speed reducer drive... compact and easy to install.
- Large, latch-type doors located on front, back and sides of boot section to facilitate inspection, service and cleanout.
- The head shaft is mounted in antifriction ball or roller bearing pillow blocks.
- Superior components... chains, sprockets, pulleys, belts, buckets, bearings, takeups and drives.

Typical bulk handling applications include:

Delivery of dry citrus pellets to railroad hopper cars.

Elevating soda ash, fertilizer or limestone to silo storage.

Depositing food products into weigh hoppers.

Lifting coal from track hoppers to storage silos.

Elevate aggregate materials for ready-mix concrete plants.

Link-Belt® Bucket Elevators from Syntron Material Handling... industry's complete line... handling hundreds of materials:

Metallic and Non-Metallic ores...
Bauxite, Coal

Rock products... Sand, Gravel, Cement, Gypsum, Limestone

Food products... Sugar, Flour, Coffee, Salt

Chemical Processing products...
Fertilizers, Phosphates, Agricultural Lime, Soda Ash

Pulp and Paper products...
Wood Chips



Link-Belt® Bucket Elevator Standardization... the key to economical design.

For most bulk material elevating jobs... there's a Link-Belt® Bucket Elevator that will handle them efficiently and economically. With over 100 years of proven experience as a pioneer and leading producer of bucket elevators, Syntron Material Handling offers a standardized line of Link-Belt® elevators proven in thousands of installations.

Standardization is a standout feature of Link-Belt® Bucket Elevators. Link-Belt® Type 1 and Type 7 Bucket Elevator designs are standardized so you benefit from the economics of many stocked components. Manufacturing methods are standardized through exacting production and fabrication to assure compatibility of components. Engineering and manufacturing procedures have also been standardized so that the selected elevator will accommodate your needs.

Balanced design of components, manufacturing craftsmanship, and the quality found in all Link-Belt® products, have all helped the Link-Belt® Bucket Elevator achieve universal acceptance.

Two basic designs of bucket elevators are available, and selection depends primarily on the material to be handled.

The **Centrifugal Discharge** design has spaced buckets that travel at a relatively high speed. It is a medium capacity unit, capable of handling materials with small-to-medium size lumps. The buckets dig the material from the casing boot section and discharge it by centrifugal force.

Type 1- Elevators of this type meet the service requirements of the majority of installations using centrifugal discharge elevators. The head shafts are fixed, with the foot shaft takeup being internal gravity type. Buckets are designed for use on either chain or belt.

For most applications, chain is recommended, however, belting is used when handling materials that must not be contaminated or for materials that are extremely abrasive and corrosive.

As an alternate to the standard Type 1 centrifugal discharge design, Type 2 design is available. The head shaft is adjustable and the boot shaft fixed to maintain the relationship of buckets to the inlet spout and curved bottom plate. Type 2 bucket elevators are recommended when handling food products; for materials that tend to pack or build-up, or when handling materials having a large percentage of lumps.

The **Continuous Discharge Design** has buckets mounted continuously that travel at a much slower speed. The continuous discharge design elevator handles a variety of materials from fines to large lumps. Materials that are difficult to pick in the casing boot section or friable are normally handled in this type elevator. The buckets are fed directly from a loading leg or chute and are emptied by gravity at the discharge point.

Type 7- This elevator is the most frequently used of the continuous discharge design. The head shafts are fixed, with foot shaft takeups being internal gravity type. Buckets are steel and spaced continuously on a strand of chain.

As an alternate to the standard Type 7 continuous discharge design, the Type 8 design is available. The head shaft is adjustable and the foot shaft is fixed. Type 8 elevators are used for the handling of fine or crushed materials with lumps not exceeding $\frac{1}{2}$ inch. With the addition of a loading leg and a correspondingly higher inlet spout, this type elevator can also be used for handling lumps up to $4\frac{1}{2}$ ".

The superior performance delivered by the Link-Belt® Bucket Elevator is the result of quality components, and each component described in this catalog has been developed as an integral part of a carefully engineered elevator design. Syntron Material Handling maintains a large inventory of bucket elevator components to meet your replacement needs.

CAUTION: Link-Belt® Bucket Elevators must be installed, operated and maintained in accordance with Syntron Material Handling Service Instructions. Failure to follow these instructions can result in serious personal injury, property damage or both.

Service Instructions are available at www.syntronmh.com

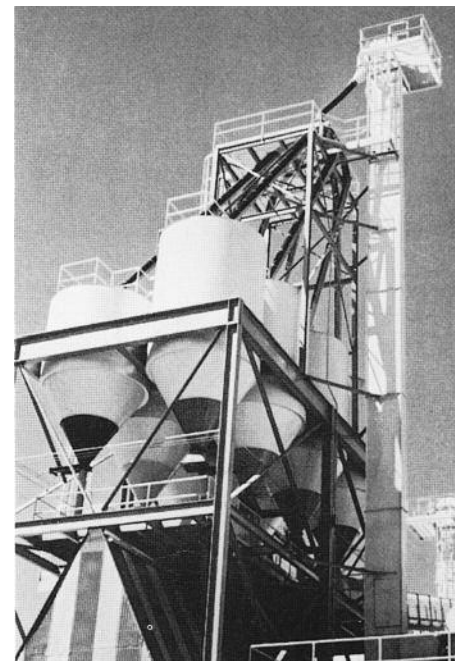

Link-Belt® Bucket Elevators handle inorganic materials at a chemical plant installation.

Selection procedure for standard Bucket Elevators Types 1 and 7.

Prior to the selection of a Link-Belt® Bucket Elevator, all specifications of the application and conditions of the installation should be reviewed. As a guide to be used in selecting the most efficient and economical Link-Belt® Bucket Elevator for an application, the following outline is offered:

1. Material Characteristics

- Abrasive, free-flowing, sluggish, temperature, fluffy, friable, degradable, etc...
- Weight per cubic foot at loading point into the bucket elevator.
- Maximum and average size of lumps- percentage of lumps.

- Maximum discharge rate (t.p.h.) required of bucket elevator.
- Center to center dimensions between head shaft and foot shaft.
- Operating conditions
 - Indoors
 - Outdoors
 - Corrosive atmosphere, etc...
- Type of service required
 - Continuous
 - Intermittent
- Calculate the volumetric capacity required (cubic feet per hour)

$$\frac{\text{Maximum discharge rate (t.p.h.)} \times 2000 \text{ pounds}}{\text{Material weight per cubic foot}} = \text{cubic feet per hour}$$

- Determine the proper type of bucket elevator required, based upon the material being handled. Refer to Table #1. If a specific material is not listed within tabulations, select a material having similar characteristics.
- With reference to volumetric capacity and percent of lump size, determine bucket elevator number using the selection tabulations provided. These tabulations also indicate head shaft size and required horsepower.

NOTE: If the "weight per cubic foot" is isolated between given values, apply the next higher figure.

Examples of Bucket Elevator Selection-

Example #1:

Material bituminous coal
 Weight 50#/cu. ft.
 Capacity 70 t. p. h.
 Maximum lump size under 1/2 inch
 Shaft centers 65 ft.
 Service 8-10 hrs. per day

Step A

Determine volumetric capacity.
 $\frac{70 \times 2000}{50} = 2800 \text{ cu. ft./hr.}$

Step B

Determine type of elevator. Table #1 indicates either a Type 1 or Type 7. However, capacity is greater than a Type 7 will handle. Select Type 1.

Step C

Refer to selection tabulations and select a #134 elevator rated 3120 cu.ft./hr. for 65 ft. cntr. A 3 7/16" diameter head shaft and 15 hp drive is required.

NOTE: A #134 elevator is fully capable of handling the 1/2" and under lumps.

Example: #2:

Material crushed limestone
 Weight 85-90#/cu. ft.
 Capacity 75 t.p.h.
 Maximum lump size .. 3/4 inch
 Shaft centers 50 ft.
 Service 8-10 hrs. per day

Step A

Determine volumetric capacity.
 $\frac{75 \times 2000}{85} = 1765 \text{ cu. ft./hr.}$

NOTE: Use light weight for volume and heavy weight for horsepower.

Step B

Determine type of elevator. Table #1 indicates a Type 7 for this material.

Step C

Refer to selection tabulations. A #781 elevator is rated 2090 cu. ft./hr. using 100#/cu. ft. and 50 ft. centers. A 3 15/16" diameter shaft and 15 hp drive is required. 3/4" lumps are within the capabilities of this elevator. A #781 elevator using Steel Bushed Chain rather than Combination Chain is preferred, since the material being handled is mildly abrasive.

Typical bulk materials handled by Bucket Elevators

Table 1

Material	Average Weight lbs. per cu. ft. Δ	Elevator Type \blacktriangle	Material	Average Weight lbs. per cu. ft. Δ	Elevator Type \blacktriangle
Alum, lumpy	50-60	7	Fuller's earth, burnt, oil refinery	40	1 ■
Aluminum chips	7-15	7	Fuller's earth, raw, oil refinery	35-40	1 ■
Aluminum oxide	67-120	7	Granite, broken	95-100	7
Bakelite, powdered	30-40	7	Gravel, screened	90-100	1,7
Bauxite, crushed 3" and under	75-85	1,7	Gypsum, calcined	55-60	1,7
Beans, navy, dry	48	1,7	Gypsum, crushed, 1" and under	90-100	1,7
Bentonite, crude	34-40	1	Gypsum, powdered	60-80	1,7
Bentonite, 100 mesh and under	50-60	1	Illmenite ore	140	1,7
Bones, crushed, 1/2" and under	35-40	1,7	Lignite, air dried	45-55	1,7
Bonemeal	55-60	1	Lime, ground, 1/8" and under	60	1,7
Borax, powdered	53	1	Lime, hydrated	40	7
Brewer's grain, spent, dry	25-30	1	Lime, pebble	53-56	1,7
Carbon black, pelletized	20-25	7	Lime, over 1/2"	53	7
Carborundum, 3" and under	100	7	Limestone, agricultural, 1/8" and under	68	1,7
Cement, Portland	65-85	1,7	Limestone, crushed	85-90	7
Chalk, crushed	85-90	1,7	Malt, dry ground, 1/8" and under	22	1
Chalk, pulverized, 100 mesh and under	70-75	7	Malt, dry, whole	27-30	1
Charcoal	18-25	7	Marble, crushed, over 1/2"	90-95	7
Cinders, coal	40	7	Muriate of potash	77	1,7
Coal, anthracite, river coal and culm 1/8" and under	60	1,7	Phosphate rock	75-85	7
Coal, bituminous, mined, slack, 1/2" and under	50	1,7	Phosphate sand	90-100	1,7
Coal, bituminous, mined, sized, over 1/2"	50	7	Salt, dry, fine	70-80	7
Coal, bituminous, stripping, not cleaned, over 1/2"	50	1,7	Salt, dry, coarse	45-50	7
Cocoa beans	30-40	1,7	Salt cake, dry, coarse	85	7
Coffee	22-26	1,7	Salt cake, dry, pulverized	65-85	7
Coke breeze, 1/4" and under	25-35	1 ■	Sand, damp bank	110-130	1 ■
Cork, granulated, 1/2" and under	12-15	7	Sand	90-110	1 ■
Corn, cracked	45-50	1	Shale, crushed	85-90	1 ■
Dolomite, crushed	90-100	7	Slag, furnace granulated	60-65	7
Ebonite, crushed, 1/2" and under	65-70	7	Slate, crushed, 1/2" and under	80-90	7
Feldspar, ground 1/8" and under	65-70	1,7	Slate, ground, 1/8" and under	82	1 ■
Feldspar, powdered, 100 mesh and under	75	7	Soda ash, light	20-35	7
Flue dust, boiler house, dry	35-40	7 □	Soda ash, heavy	55-65	1,7
Fluorspar	82	1,7	Sugar beet, pulp, dry	12-15	7
			Sugar, raw	55-65	1
			Wood chips	12-20	1 ■

\blacktriangle Chain recommended for all elevators except those marked ■, where belts are recommended. To avoid damage to belt, provide foot shafts with welded steel wing pulleys where there is a tendency for material to pack between belt and pulley.

Δ Weight of material loose or slightly agitated. This weight is generally less than that of settled or packed material, as in bins or containers.

□ Select an elevator having twice the capacity required.

Link-Belt® Bucket Elevators

Type 1-Chain or Belt

A centrifugal discharge bucket elevator-rugged construction with quality components-industry's leader in the handling of free-flowing, fine and loose material with small to medium size lumps.

Bucket spacing and speed is important for centrifugal discharge bucket elevators. The Link-Belt® Type 1 Bucket Elevator can be relied upon to elevate and discharge materials at rated capacities.

In selection of quality components, Syntron Material Handling engineers have, based upon laboratory tests, taken into consideration the critical speed of operation that exists with bucket elevators. The critical speed of operation is the speed at which the actual capacity of the elevator drops below the theoretical capacity, and exists when the centrifugal force at the mass center of the material in the bucket is equal to the gravitational force on the material. All Link-Belt® centrifugal type discharge bucket elevators operate below the critical speed.

Years of dependable, service-proven performance with built-in quality design features-your assurance of maximum efficiency:

- Properly spaced buckets, mounted on durable, strong chain or tough wear resistant belt, to provide the most efficient operation per dollar invested. Belt elevators with Link-Belt® wing-type pulleys are recommended when handling bulk materials with abrasive characteristics, moderate temperatures or excessive moisture content.
- Fixed head shaft with an internal gravity actuated takeup in the boot. Bearings on the takeup frame are hard iron, with the takeup shaft having induction hardened journals.
- Boot section is totally enclosed with large inspection doors to facilitate bearing replacement or the removal of the entire takeup frame.

- Hood section is removable in two sections, and the use of waste pack seals provide added protection for the head shaft.
- Standard drive is a shaft mounted speed reducer with a built-in backstop. Other drives are available.

- The rigid, strong, jig-built casings are fabricated from steel plate for years of rugged operation.
- Continuously welded casings are also available.

Type 1 Bucket Elevator

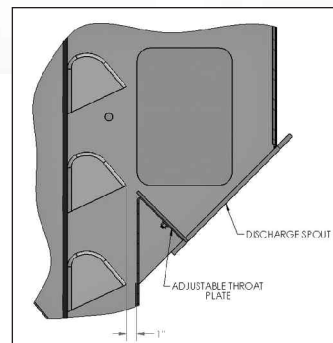
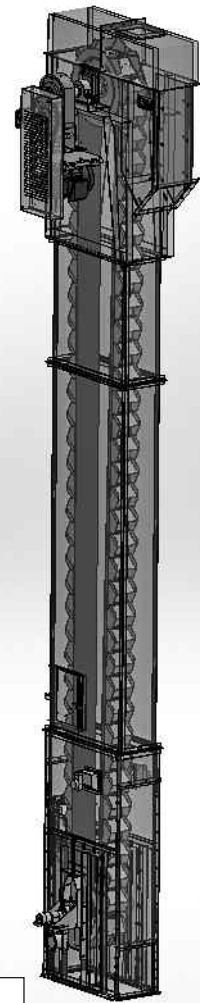
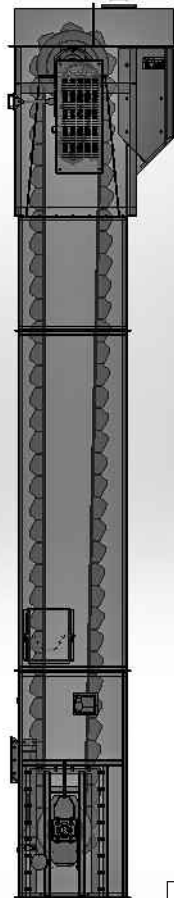

Bucket Elevator selection/specifications

Type 1-Chain

Dimensions in inches

▲ Elev. No.	△ Cu Ft. Per Hour	■ Buckets		Chain	FPM	Max. Lump Size		Casing	Headshaft			Footshaft		
		Size	Space			100%	10%		Sprkt.		RPM	Sprkt.		Dia.
									Teeth	Pitch Dia.		Teeth	Pitch Dia.	
102	280	6 X 4	13	C188	225	½	2½	9¾ X 35	24	20	43	18	15	1½
107	612	8 X 5	16	C102B	260	¾	3	11¾ X 42	19	24¼	41	14	18	2
108		8 X 5	16	SBS102B	260	¾	3	11¾ X 42	19	24¼	41	14	18	2
112	960	10 X 6	18	C110	268	1	3½	13¾ X 48	13	25	41	11	21¼	2
113		10 X 6	18	SBS110	268	1	3½	13¾ X 48	13	25	41	11	21¼	2
117	1536	12 X 7	18	SBS110	268	1¼	4	15¾ X 48	13	25	41	9	17½	2
128	2112	14 X 7	18	SBS110	306	1¼	4	17¾ X 54	16	30¼	38	12	23¼	2⅞
134	3120	16 X 8	18	SBS110	306	1½	4½	19¾ X 54	16	30¼	38	11	21¼	2⅞

Shaded lines indicate standard design SIBS steel bushed chain.

▲ Bucket Elevator assemblies include head shaft machinery with either ball or roller bearing pillow blocks, chain, buckets, casing, Style 1 or Style 2 discharge spout, stub inlet and gravity takeup with hard iron bearings. (Internal gravity takeup is available with cement mill type sleeves and bearings when handling highly abrasive materials). Drives with backstops, service platforms and ladders with safety cages can be furnished.

■ Style AA buckets.

△ Based upon buckets filled to 75% of theoretical capacity.

○ Based upon buckets filled to 100% of theoretical capacity. If exact material weight is not shown, select drive and head shaft using the next heavier material weight.

Centers (Ctrs.) and Head Shaft (Hd. Sft.) Dimensions in inches.

Elev No.	○ Material weight, pounds per cubic foot														
	35#/Cu. Ft.			50#/Cu. Ft.			60#/Cu. Ft.			75#/Cu. Ft.			100#/Cu. Ft.		
	Ctrs.	Hd. Sft.	HP	Ctrs.	Hd. Sft.	HP	Ctrs.	Hd. Sft.	HP	Ctrs.	Hd. Sft.	HP	Ctrs.	Hd. Sft.	HP
102	Up to 87	1 ⁵ / ₁₆	1	Up to 73	1 ⁵ / ₁₆	1	Up to 58	1 ⁵ / ₁₆	1	Up to 43	1 ⁵ / ₁₆	1	Up to 28	1 ⁵ / ₁₆	1
	88 to 100	2 ⁷ / ₁₆	1	74 to 83	1 ⁵ / ₁₆	1 ¹ / ₂	59 to 80	1 ⁵ / ₁₆	1 ¹ / ₂	44 to 73	1 ⁵ / ₁₆	1 ¹ / ₂	29 to 50	1 ⁵ / ₁₆	1 ¹ / ₂
				84 to 100	2 ⁷ / ₁₆	1 ¹ / ₂	81 to 95	2 ⁷ / ₁₆	1 ¹ / ₂	74 to 100	2 ⁷ / ₁₆	2	51 to 69	1 ⁵ / ₁₆	2
							96 to 100	2 ⁷ / ₁₆	2				70 to 97	2 ⁷ / ₁₆	3
107	Up to 38	1 ⁵ / ₁₆	1	Up to 20	1 ⁵ / ₁₆	1	Up to 13	1 ⁵ / ₁₆	1	Up to 20	1 ⁵ / ₁₆	1 ¹ / ₂	Up to 10	1 ⁵ / ₁₆	1 ¹ / ₂
	39 to 67	2 ⁷ / ₁₆	1 ¹ / ₂	21 to 35	1 ⁵ / ₁₆	1 ¹ / ₂	14 to 30	1 ⁵ / ₁₆	1 ¹ / ₂	21 to 30	1 ⁵ / ₁₆	2	11 to 20	1 ⁵ / ₁₆	2
	68 to 93	2 ⁷ / ₁₆	2	36 to 61	2 ⁷ / ₁₆	2	31 to 47	2 ⁷ / ₁₆	2	31 to 61	2 ⁷ / ₁₆	3	21 to 41	2 ⁷ / ₁₆	3
	94 to 100	2 ⁵ / ₁₆	3	62 to 88	2 ⁷ / ₁₆	3	48 to 82	2 ⁷ / ₁₆	3	62 to 80	2 ⁷ / ₁₆	5	42 to 72	2 ⁷ / ₁₆	5
			89 to 100	2 ⁵ / ₁₆	3	83 to 100	2 ⁵ / ₁₆	5	81 to 100	2 ⁵ / ₁₆	5	73 to 82	2 ⁵ / ₁₆	5	
												83 to 100	2 ⁵ / ₁₆	7 ¹ / ₂	
112	Up to 13	1 ⁵ / ₁₆	1	Up to 15	1 ⁵ / ₁₆	1 ¹ / ₂	Up to 19	1 ⁵ / ₁₆	2	Up to 10	1 ⁵ / ₁₆	2	Up to 10	1 ⁵ / ₁₆	3
	14 to 27	1 ⁵ / ₁₆	1 ¹ / ₂	16 to 22	1 ⁵ / ₁₆	2	20 to 41	2 ⁷ / ₁₆	3	11 to 28	2 ⁷ / ₁₆	3	11 to 15	2 ⁷ / ₁₆	3
	28 to 50	2 ⁷ / ₁₆	2	23 to 54	2 ⁷ / ₁₆	3	42 to 62	2 ⁷ / ₁₆	5	29 to 56	2 ⁷ / ₁₆	5	16 to 41	2 ⁷ / ₁₆	5
	51 to 73	2 ⁷ / ₁₆	3	55 to 66	2 ⁷ / ₁₆	5	63 to 85	2 ⁵ / ₁₆	5	57 to 63	2 ⁵ / ₁₆	5	42 to 47	2 ⁷ / ₁₆	7 ¹ / ₂
74 to 88	2 ⁵ / ₁₆	3	67 to 100	2 ⁵ / ₁₆	5	86 to 100	2 ⁵ / ₁₆	7 ¹ / ₂	64 to 100	2 ⁵ / ₁₆	7 ¹ / ₂	48 to 74	2 ⁵ / ₁₆	7 ¹ / ₂	
89 to 100	2 ⁵ / ₁₆	5										75 to 100	2 ⁵ / ₁₆	10	
117	Up to 15	1 ⁵ / ₁₆	1 ¹ / ₂	Up to 12	1 ⁵ / ₁₆	2	Up to 21	2 ⁷ / ₁₆	3	Up to 13	2 ⁷ / ₁₆	3	Up to 21	2 ⁷ / ₁₆	5
	16 to 27	2 ⁷ / ₁₆	2	13 to 29	2 ⁷ / ₁₆	3	22 to 38	2 ⁷ / ₁₆	5	14 to 33	2 ⁷ / ₁₆	5	22 to 26	2 ⁷ / ₁₆	7 ¹ / ₂
	28 to 48	2 ⁷ / ₁₆	3	30 to 42	2 ⁷ / ₁₆	5	39 to 48	2 ⁵ / ₁₆	5	34 to 62	2 ⁵ / ₁₆	7 ¹ / ₂	27 to 41	2 ⁵ / ₁₆	7 ¹ / ₂
	49 to 96	2 ⁵ / ₁₆	5	43 to 62	2 ⁵ / ₁₆	5	49 to 81	2 ⁵ / ₁₆	7 ¹ / ₂	63 to 73	2 ⁵ / ₁₆	10	42 to 62	2 ⁵ / ₁₆	10
97 to 100	3 ⁷ / ₁₆	7 ¹ / ₂	63 to 87	2 ⁵ / ₁₆	7 ¹ / ₂	82 to 100	3 ⁷ / ₁₆	10	74 to 89	3 ⁷ / ₁₆	10	63 to 100	3 ⁷ / ₁₆	15	
			88 to 100	3 ⁷ / ₁₆	7 ¹ / ₂				90 to 100	3 ⁷ / ₁₆	15				
128	Up to 24	2 ⁷ / ₁₆	3	Up to 27	2 ⁷ / ₁₆	5	Up to 22	2 ⁷ / ₁₆	5	Up to 12	2 ⁷ / ₁₆	5	Up to 17	2 ⁵ / ₁₆	7 ¹ / ₂
	25 to 34	2 ⁷ / ₁₆	5	28 to 62	2 ⁵ / ₁₆	7 ¹ / ₂	23 to 47	2 ⁵ / ₁₆	7 ¹ / ₂	13 to 17	2 ⁷ / ₁₆	7 ¹ / ₂	18 to 32	2 ⁵ / ₁₆	10
	35 to 58	2 ⁵ / ₁₆	5	63 to 92	3 ⁷ / ₁₆	10	48 to 57	2 ⁵ / ₁₆	10	18 to 32	2 ⁵ / ₁₆	7 ¹ / ₂	33 to 38	2 ⁵ / ₁₆	15
	59 to 73	2 ⁵ / ₁₆	7 ¹ / ₂	93 to 100	3 ⁷ / ₁₆	15	58 to 72	3 ⁷ / ₁₆	10	33 to 49	2 ⁵ / ₁₆	10	39 to 62	3 ⁷ / ₁₆	15
74 to 100	3 ⁷ / ₁₆	7 ¹ / ₂				73 to 100	3 ⁷ / ₁₆	15	50 to 92	3 ⁷ / ₁₆	15	63 to 76	3 ⁷ / ₁₆	20	
									93 to 100	3 ⁷ / ₁₆	20	77 to 92	3 ⁷ / ₁₆	20	
												93 to 100	3 ⁷ / ₁₆	25	
134	Up to 32	2 ⁵ / ₁₆	5	Up to 15	2 ⁵ / ₁₆	5	Up to 25	2 ⁵ / ₁₆	7 ¹ / ₂	Up to 15	2 ⁵ / ₁₆	7 ¹ / ₂	Up to 15	2 ⁵ / ₁₆	10
	33 to 46	2 ⁵ / ₁₆	7 ¹ / ₂	16 to 35	2 ⁵ / ₁₆	7 ¹ / ₂	26 to 33	2 ⁵ / ₁₆	10	16 to 26	2 ⁵ / ₁₆	10	16 to 35	3 ⁷ / ₁₆	15
	47 to 61	3 ⁷ / ₁₆	7 ¹ / ₂	36 to 55	3 ⁷ / ₁₆	10	34 to 42	3 ⁷ / ₁₆	10	27 to 55	3 ⁷ / ₁₆	15	36 to 44	3 ⁷ / ₁₆	20
	62 to 82	3 ⁷ / ₁₆	10	56 to 71	3 ⁷ / ₁₆	15	43 to 65	3 ⁷ / ₁₆	15	56 to 82	3 ⁷ / ₁₆	20	45 to 55	3 ⁷ / ₁₆	20
83 to 90	3 ⁷ / ₁₆	10	72 to 96	3 ⁷ / ₁₆	15	66 to 76	3 ⁷ / ₁₆	15				56 to 76	3 ⁷ / ₁₆	25	
						77 to 100	3 ⁷ / ₁₆	20							

Bucket Elevator selection/specifications

Type 1-Belt

Dimensions in inches

▲ Elev. No.	△ Cu. Ft. Per Hour	■ Buckets		Belt Width	Belt Rating P.I.W.	FPM	Max. Lump Size		Casing	Headshaft		Footshaft	
		Size	Space				100%	10%		Pulley Dia.	RPM	Pulley Dia.	Dia.
141	280	6 X 4	13	7	160	225	½	2½	11¼ X 35	20	43	16	1½
143	609	8 X 5	16	9	160	258	¾	3	13¼ X 42	24	41	18	2
145	1045	10 X 6	16	11	240	258	1	3½	15¼ X 48	24	41	20	2
147	1698	12 X 7	18	13	240	298	1¼	4	17¼ X 54	30	38	24	2⅞
149	2056	14 X 7	18	15	240	298	1¼	4	19¼ X 54	30	38	24	2⅞
152	3039	16 X 8	18	18	320	298	1½	4½	22¼ X 54	30	38	24	2⅞

▲ Bucket Elevator assemblies include head shaft machinery with either ball or roller bearing pillow blocks, chain, buckets, casing, Style 1 or Style 2 discharge spout, stub inlet and gravity takeup with hard iron bearings, (internal gravity takeup is available with cement mill type sleeves and bearings when handling highly abrasive materials). Drives with backstops, service platforms and ladders with safety cages can be furnished.

■ Style AA buckets.

△ Based upon buckets filled to 75% of theoretical capacity.

○ Based upon buckets filled to 100% of theoretical capacity. If exact material weight is not shown, select drive and head shaft using the next heavier material weight.

Centers (Ctrs.) and Head Shaft (Hd. Sft.) Dimensions in inches.

Elev. No.	○ Material weight, pounds per cubic foot															
	35#/Cu. Ft.			50#/Cu. Ft.			60#/Cu. Ft.			75#/Cu. Ft.			100#/Cu. Ft.			
	Ctrs.	Hd. Sft.	HP	Ctrs.	Hd. Sft.	HP	Ctrs.	Hd. Sft.	HP	Ctrs.	Hd. Sft.	HP	Ctrs.	Hd. Sft.	HP	
141	Up to 100	1 ¹⁵ / ₁₆	1	Up to 72	1 ¹⁵ / ₁₆	1	Up to 57	1 ¹⁵ / ₁₆	1	Up to 42	1 ¹⁵ / ₁₆	1	Up to 27	1 ¹⁵ / ₁₆	1	
				73 to 100	1 ¹⁵ / ₁₆	1 ¹ / ₂	58 to 94	1 ¹⁵ / ₁₆	1 ¹ / ₂	43 to 72	1 ¹⁵ / ₁₆	1 ¹ / ₂	28 to 49	1 ¹⁵ / ₁₆	1 ¹ / ₂	
							95 to 100	1 ¹⁵ / ₁₆	2	73 to 100	1 ¹⁵ / ₁₆	2	50 to 72	1 ¹⁵ / ₁₆	2	
143	Up to 38	1 ¹⁵ / ₁₆	1	Up to 20	1 ¹⁵ / ₁₆	1	Up to 13	1 ¹⁵ / ₁₆	1	Up to 20	1 ¹⁵ / ₁₆	1 ¹ / ₂	Up to 10	1 ¹⁵ / ₁₆	1 ¹ / ₂	
	39 to 67	1 ¹⁵ / ₁₆	1 ¹ / ₂	21 to 41	1 ¹⁵ / ₁₆	1 ¹ / ₂	14 to 30	1 ¹⁵ / ₁₆	1 ¹ / ₂	21 to 34	1 ¹⁵ / ₁₆	2	11 to 20	1 ¹⁵ / ₁₆	2	
	68 to 97	1 ¹⁵ / ₁₆	2	42 to 61	1 ¹⁵ / ₁₆	2	31 to 48	1 ¹⁵ / ₁₆	2	35 to 61	1 ¹⁵ / ₁₆	3	21 to 41	1 ¹⁵ / ₁₆	3	
	98 to 100	1 ¹⁵ / ₁₆	3	62 to 100	1 ¹⁵ / ₁₆	3	49 to 82	1 ¹⁵ / ₁₆	3	62 to 90	1 ¹⁵ / ₁₆	5	42 to 73	1 ¹⁵ / ₁₆	5	
																83 to 100
145	Up to 11	1 ¹⁵ / ₁₆	1	Up to 13	1 ¹⁵ / ₁₆	1 ¹ / ₂	Up to 17	1 ¹⁵ / ₁₆	2	Up to 25	1 ¹⁵ / ₁₆	3	Up to 13	1 ¹⁵ / ₁₆	3	
	12 to 29	1 ¹⁵ / ₁₆	1 ¹ / ₂	14 to 25	1 ¹⁵ / ₁₆	2	18 to 37	1 ¹⁵ / ₁₆	3	26 to 48	1 ¹⁵ / ₁₆	5	14 to 35	1 ¹⁵ / ₁₆	5	
147	30 to 46	1 ¹⁵ / ₁₆	2	26 to 49	1 ¹⁵ / ₁₆	3	38 to 57	1 ¹⁵ / ₁₆	5	49 to 57	2 ⁷ / ₁₆	5	36 to 67	2 ⁷ / ₁₆	7 ¹ / ₂	
	47 to 78	1 ¹⁵ / ₁₆	3	50 to 64	1 ¹⁵ / ₁₆	5	58 to 77	2 ⁷ / ₁₆	5	58 to 98	2 ⁷ / ₁₆	7 ¹ / ₂	68 to 92	2 ⁷ / ₁₆	10	
	79 to 100	2 ⁷ / ₁₆	5	65 to 98	2 ⁷ / ₁₆	5	78 to 100	2 ⁷ / ₁₆	7 ¹ / ₂	99 to 100	2 ⁷ / ₁₆	10	93 to 100	2 ¹⁵ / ₁₆	15	
	149	Up to 15	2 ⁷ / ₁₆	2	Up to 17	2 ⁷ / ₁₆	3	Up to 34	2 ⁷ / ₁₆	5	Up to 22	2 ⁷ / ₁₆	5	Up to 28	2 ⁷ / ₁₆	7 ¹ / ₂
16 to 36		2 ⁷ / ₁₆	3	18 to 46	2 ⁷ / ₁₆	5	35 to 65	2 ⁷ / ₁₆	7 ¹ / ₂	23 to 46	2 ⁷ / ₁₆	7 ¹ / ₂	29 to 46	2 ⁷ / ₁₆	10	
37 to 78		2 ⁷ / ₁₆	5	47 to 84	2 ⁷ / ₁₆	7 ¹ / ₂	67 to 85	2 ⁷ / ₁₆	10	47 to 69	2 ⁷ / ₁₆	10	47 to 50	2 ⁷ / ₁₆	15	
79 to 100		2 ⁷ / ₁₆	7 ¹ / ₂	85 to 97	2 ⁷ / ₁₆	10	86 to 96	2 ¹⁵ / ₁₆	10	86 to 96	2 ¹⁵ / ₁₆	10	51 to 84	2 ¹⁵ / ₁₆	15	
																98 to 100
152	Up to 25	2 ⁷ / ₁₆	3	Up to 33	2 ⁷ / ₁₆	5	Up to 23	2 ⁷ / ₁₆	5	Up to 13	2 ⁷ / ₁₆	5	Up to 18	2 ⁷ / ₁₆	7 ¹ / ₂	
	26 to 60	2 ⁷ / ₁₆	5	34 to 64	2 ⁷ / ₁₆	7 ¹ / ₂	29 to 49	2 ⁷ / ₁₆	7 ¹ / ₂	14 to 33	2 ⁷ / ₁₆	7 ¹ / ₂	19 to 33	2 ⁷ / ₁₆	10	
	61 to 91	2 ⁷ / ₁₆	7 ¹ / ₂	65 to 72	2 ⁷ / ₁₆	10	50 to 62	2 ⁷ / ₁₆	10	34 to 49	2 ⁷ / ₁₆	10	34 to 64	2 ¹⁵ / ₁₆	15	
	92 to 100	2 ¹⁵ / ₁₆	7 ¹ / ₂	73 to 95	2 ¹⁵ / ₁₆	10	63 to 74	2 ¹⁵ / ₁₆	10	63 to 74	2 ¹⁵ / ₁₆	10	65 to 79	2 ¹⁵ / ₁₆	20	
																96 to 100
152	Up to 31	2 ¹⁵ / ₁₆	5	Up to 13	2 ¹⁵ / ₁₆	5	Up to 24	2 ¹⁵ / ₁₆	7 ¹ / ₂	Up to 13	2 ¹⁵ / ₁₆	7 ¹ / ₂	Up to 13	2 ¹⁵ / ₁₆	10	
	32 to 61	2 ¹⁵ / ₁₆	7 ¹ / ₂	14 to 34	2 ¹⁵ / ₁₆	7 ¹ / ₂	25 to 41	2 ¹⁵ / ₁₆	10	14 to 27	2 ¹⁵ / ₁₆	10	14 to 34	2 ¹⁵ / ₁₆	15	
	62 to 91	2 ¹⁵ / ₁₆	10	35 to 55	2 ¹⁵ / ₁₆	10	42 to 76	2 ¹⁵ / ₁₆	15	42 to 76	2 ¹⁵ / ₁₆	15	28 to 55	2 ¹⁵ / ₁₆	15	
																92 to 100
				93 to 97	3 ⁷ / ₁₆	15					66 to 83	3 ⁷ / ₁₆	20	48 to 55	3 ⁷ / ₁₆	20
				98 to 100	3 ⁷ / ₁₆	20					84 to 100	3 ⁷ / ₁₆	25	56 to 76	3 ⁷ / ₁₆	25
														77 to 89	3 ⁷ / ₁₆	30
														90 to 97	3 ¹⁵ / ₁₆	30

Type 1-Chain or Belt ■

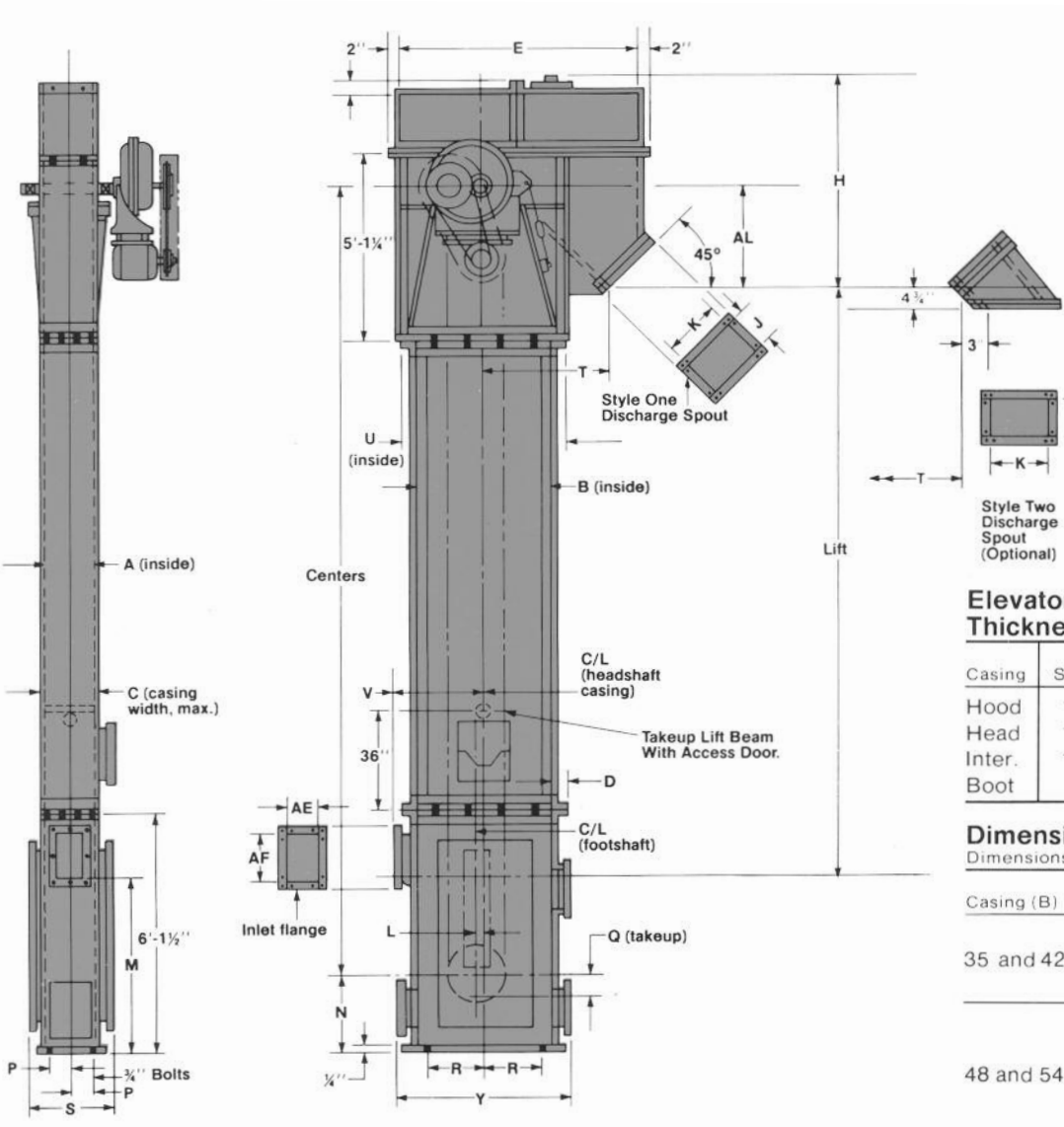

Elevator Casing Thicknesses

Casing	Standard	Heavy-Duty	Extra Heavy-Duty
Hood	14 Ga.	12 Ga.	12 Ga.
Head	12 Ga.	10 Ga.	7 Ga.
Inter.	12 Ga.	10 Ga.	7 Ga.
Boot	7 Ga.	7 Ga.	¼"

Dimension AL

Dimensions in inches

Casing (B)	Shaft (Dia.)	Ball Bearing	Roller Bearing
35 and 42	1 ¹¹ / ₁₆	34 ¹ / ₂	34 ¹ / ₂
	2 ⁷ / ₁₆	34 ¹⁵ / ₁₆	35
	2 ¹ / ₁₆	35 ¹ / ₂	35 ¹ / ₂
48 and 54	1 ¹¹ / ₁₆	35 ³ / ₄	35 ³ / ₄
	2 ⁷ / ₁₆	36 ³ / ₁₆	36 ³ / ₄
	2 ¹ / ₁₆	36 ³ / ₄	36 ³ / ₄
	3 ⁷ / ₁₆	37 ¹ / ₄	37 ¹ / ₄
	3 ¹¹ / ₁₆	37 ¹⁵ / ₁₆	37 ³ / ₄

Dimensions in inches

Elevator Number	Casing Size A x B	C	D	E	H	○ J	K	L	▲ M	N	P	Q	R	S	T	U	V	Y	AE	AF
102	9 ³ / ₄ x 35	14 ¹ / ₈	1 ¹ / ₂	57 ¹ / ₄	59 ¹ / ₄	9 ⁷ / ₈	13	2 ¹ / ₂	27 ¹ / ₂	20 ¹ / ₂	6 ³ / ₄	6	14 ¹ / ₂	17 ³ / ₄	27	42	20 ¹ / ₂	42 ¹ / ₂	6	12
141	11 ¹ / ₄ x 35	16 ¹ / ₈	1 ¹ / ₂	57 ¹ / ₄	59 ¹ / ₄	11 ¹ / ₈	13	2 ¹ / ₂	27 ¹ / ₂	20 ¹ / ₂	7 ³ / ₄	6	14 ¹ / ₂	19 ³ / ₄	27	42	20 ¹ / ₂	42 ¹ / ₂	6	12
107, 108	11 ¹ / ₄ x 42	16 ¹ / ₈	2	57 ¹ / ₄	59 ¹ / ₄	11 ¹ / ₈	13	3	31 ¹ / ₂	24 ¹ / ₂	7 ³ / ₄	8	18	19 ³ / ₄	27	42	24	49 ¹ / ₂	6	12
143	13 ³ / ₄ x 42	18 ¹ / ₈	2	57 ¹ / ₄	59 ¹ / ₄	13 ¹ / ₈	13	3	31 ¹ / ₂	24 ¹ / ₂	8 ³ / ₄	8	18	21 ³ / ₄	27	42	24	49 ¹ / ₂	6	15
112, 113	13 ³ / ₄ x 48	18 ¹ / ₈	2	72	67	13 ³ / ₈	17	3	34	27	8 ³ / ₄	8	21	21 ³ / ₄	33	54	27	55 ¹ / ₂	8	15
117, 145	15 ³ / ₄ x 48	20 ¹ / ₈	2	72	67	15 ¹ / ₈	17	3	34	27	9 ³ / ₄	8	21	23 ³ / ₄	33	54	27	55 ¹ / ₂	10★	15
128, 147	17 ³ / ₄ x 54	22 ¹ / ₈	2	72	67	17 ¹ / ₈	17	3	38 ¹ / ₂	31 ¹ / ₂	10 ³ / ₄	10	24	25 ³ / ₄	33	54	30	61 ¹ / ₂	14★	18
134, 149	19 ³ / ₄ x 54	24 ¹ / ₈	2	72	67	19 ¹ / ₈	17	3	38 ¹ / ₂	31 ¹ / ₂	11 ³ / ₄	10	24	27 ³ / ₄	33	54	30	61 ¹ / ₂	14★	18
152	22 ³ / ₄ x 54	27 ¹ / ₈	2	72	67	22 ¹ / ₈	17	3	38 ¹ / ₂	31 ¹ / ₂	13 ³ / ₄	10	24	30 ³ / ₄	33	54	30	61 ¹ / ₂	14	18

○ For 10 and 12 gauge discharge spout. Deduct 1/8" for 7 gauge discharge spout.
 ▲ Minimum dimension for efficient loading.
 ★ Deduct 2" for Type 1 Belt # 145, #147 and #149.
 ■ Dimensions should not be used for Type 2 Elevators. Consult Syntron Material Handling for dimensional data.

Link-Belt® Bucket Elevator Type 7-Chain

High-capacity continuous discharge bucket elevator... with overlapping arrangement of buckets to handle a variety of materials from fines to large lumps. The Type 7 bucket elevator is the most frequently used of the continuous discharge styles, with material loaded directly into the bucket through a loading leg, that confines the feed and prevents spillage into the boot.

The continuous discharge bucket elevator travels at a much slower speed than its counterpart, the centrifugal discharge bucket elevator. Standard operating speed is 125 fpm. When handling light or fluffy-type material, operating speeds of 160-175 fpm are common. When bulk material is abrasive, operating speeds are normally reduced for longer component life.

Years of dependable, service-proven performance with built-in quality design features, your assurance of maximum efficiency:

- Fixed head shafts.
- Internal gravity operated takeups.
- Continuously spaced steel buckets on a single strand of chain.
- Boot section is totally enclosed with large inspection doors to facilitate bearing replacement of the removal of the entire takeup frame.
- Hood section is removable in two sections, and the use of waste pack seals provide added protection for the head shaft.
- Standard drive is a shaft mounted speed reducer with a built-in backstop. Other drives are available.
- The rigid, strong jig-built casings are fabricated from steel plate for many years of rugged operation. Weather tight casings are also available.

Type 7 Bucket Elevator

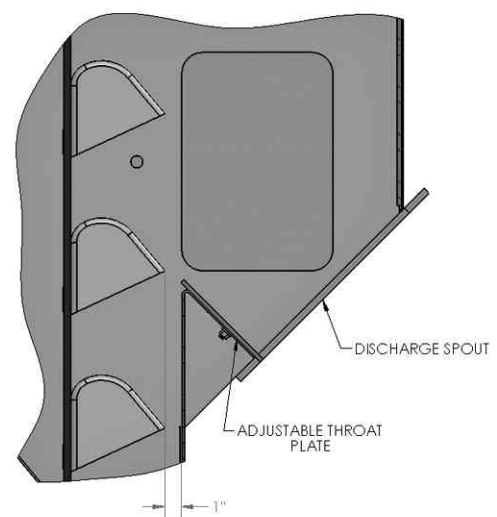
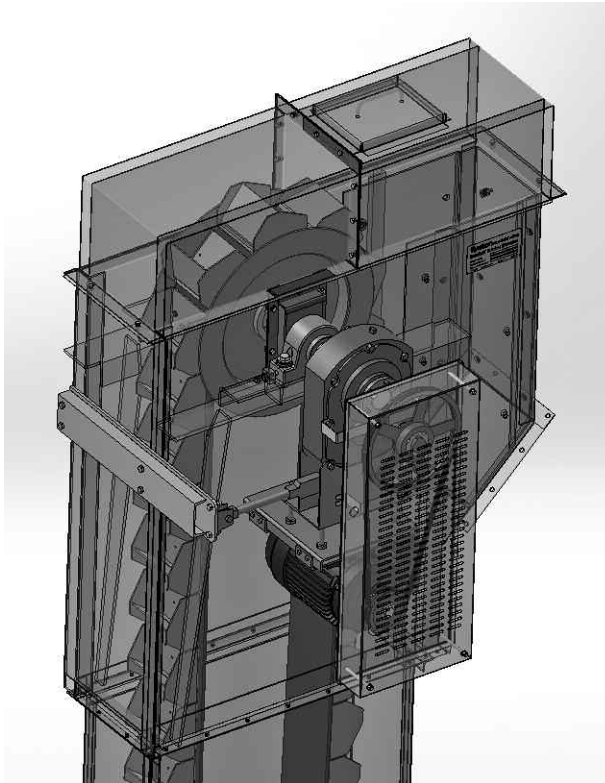

Bucket Elevator selection/specifications

Type 7-Chain

▲ Elev. No.	△ Cu. Ft Per Hour	■ Buckets		Chain	FPM	Max. Lump Size		Casing	Headshaft			Footshaft		
		Size	Space			100%	10%		Sprkt.		RPM	Sprkt.		Dia.
									Teeth	Pitch Dia.		Teeth	Pitch Dia.	
766	590	8 X 5 X 7 $\frac{3}{4}$	8	C102B	125	$\frac{3}{4}$	2 $\frac{1}{2}$	11 $\frac{1}{4}$ X 39	16	20 $\frac{1}{2}$	23.4	11	14 $\frac{1}{4}$	1 $\frac{1}{2}$
767	590	8 X 5 X 7 $\frac{3}{4}$	8	SBS102B	125	$\frac{3}{4}$	2 $\frac{1}{2}$	11 $\frac{1}{4}$ X 39	16	20 $\frac{1}{2}$	23.4	11	14 $\frac{1}{4}$	1 $\frac{1}{2}$
768	750	10 X 5 X 7 $\frac{3}{4}$	8	C102B	125	$\frac{3}{4}$	2 $\frac{1}{2}$	13 $\frac{3}{4}$ X 39	16	20 $\frac{1}{2}$	23.4	11	14 $\frac{1}{4}$	1 $\frac{1}{2}$
769	750	10 X 5 X 7 $\frac{3}{4}$	8	SBS102B	125	$\frac{3}{4}$	2 $\frac{1}{2}$	13 $\frac{3}{4}$ X 39	16	20 $\frac{1}{2}$	23.4	11	14 $\frac{1}{4}$	1 $\frac{1}{2}$
770	1010	10 X 7 X 11 $\frac{5}{8}$	12	C110	125	1	3	13 $\frac{3}{4}$ X 48	13	25	19.1	10	19 $\frac{1}{2}$	2
771	1010	10 X 7 X 11 $\frac{5}{8}$	12	SBS110	125	1	3	13 $\frac{3}{4}$ X 48	13	25	19.1	10	19 $\frac{1}{2}$	2
776	1550	12 X 8 X 11 $\frac{5}{8}$	12	C110	125	1 $\frac{1}{4}$	4	15 $\frac{3}{4}$ X 48	13	25	19.1	9	17 $\frac{1}{2}$	2
777	1550	12 X 8 X 11 $\frac{5}{8}$	12	SBS110	125	1 $\frac{1}{4}$	4	15 $\frac{3}{4}$ X 48	13	25	19.1	9	17 $\frac{1}{2}$	2
781	2090	16 X 8 X 11 $\frac{5}{8}$	12	SBS110	125	1 $\frac{1}{2}$	4 $\frac{1}{2}$	19 $\frac{1}{4}$ X 48	13	25	19.1	9	17 $\frac{1}{2}$	2 $\frac{1}{8}$
783	2340	18 X 8 X 11 $\frac{5}{8}$	12	SBS110	125	1 $\frac{1}{2}$	4 $\frac{1}{2}$	21 $\frac{1}{4}$ X 48	13	25	19.1	9	17 $\frac{1}{2}$	2 $\frac{1}{8}$

Shaded lines indicate standard design SIBS steel bushed chain.

▲ Bucket Elevator assemblies include head shaft machinery with either ball or roller bearing pillow blocks, chain, buckets, casing, Style 1 or Style 2 discharge spout, stub inlet and gravity takeup with hard iron bearings. (Internal gravity takeup is available with cement mill type sleeves and bearings when handling highly abrasive materials). Drives with backstops, service platforms and ladders with safety cages can be furnished.

■ Style MF, medium front, continuous steel buckets.

△ Based upon buckets filled to 75% of theoretical capacity.

○ Based upon buckets filled to 100% of theoretical capacity. If exact material weight is not shown, select drive and head shaft using the next heavier material weight.

Elev. No.	⊗ Material weight, pounds per cubic foot														
	35#/Cu. Ft.			50#/Cu. Ft.			60#/Cu. Ft.			75#/Cu. Ft.			100#/Cu. Ft.		
	Ctrs.	Hd. Sft.	HP	Ctrs.	Hd. Sft.	HP	Ctrs.	Hd. Sft.	HP	Ctrs.	Hd. Sft.	HP	Ctrs.	Hd. Sft.	HP
766	Up to 25	1 ¹⁵ / ₁₆	1	Up to 22	1 ¹⁵ / ₁₆	1	Up to 20	1 ¹⁵ / ₁₆	1	Up to 16	1 ¹⁵ / ₁₆	1	Up to 10	1 ¹⁵ / ₁₆	1
767	26 to 44	2 ⁷ / ₁₆	1	23 to 28	2 ⁷ / ₁₆	1	21 to 40	2 ⁷ / ₁₆	1 ¹ / ₂	17 to 30	2 ⁷ / ₁₆	1 ¹ / ₂	11 to 20	2 ⁷ / ₁₆	1 ¹ / ₂
	45 to 62	2 ⁷ / ₁₆	1 ¹ / ₂	29 to 50	2 ⁷ / ₁₆	1 ¹ / ₂	41 to 55	2 ⁷ / ₁₆	2	31 to 44	2 ⁷ / ₁₆	2	21 to 31	2 ⁷ / ₁₆	2
	63 to 75	2 ¹⁵ / ₁₆	1 ¹ / ₂	51 to 58	2 ⁷ / ₁₆	2	56 to 93	2 ¹⁵ / ₁₆	3	45 to 51	2 ⁷ / ₁₆	3	32 to 45	2 ⁷ / ₁₆	3
	76 to 100	2 ¹⁵ / ₁₆	2	59 to 71	2 ¹⁵ / ₁₆	2	94 to 100	2 ¹⁵ / ₁₆	5	52 to 73	2 ¹⁵ / ₁₆	3	46 to 52	2 ¹⁵ / ₁₆	3
				72 to 100	2 ¹⁵ / ₁₆	3				74 to 100	2 ¹⁵ / ₁₆	5	53 to 91	2 ¹⁵ / ₁₆	5
													92 to 100	3 ⁷ / ₁₆	7 ¹ / ₂
768	Up to 18	1 ¹⁵ / ₁₆	1	Up to 15	1 ¹⁵ / ₁₆	1	Up to 13	1 ¹⁵ / ₁₆	1	Up to 10	1 ¹⁵ / ₁₆	1	Up to 14	2 ⁷ / ₁₆	1 ¹ / ₂
769	19 to 32	2 ⁷ / ₁₆	1	16 to 20	2 ⁷ / ₁₆	1	14 to 29	2 ⁷ / ₁₆	1 ¹ / ₂	11 to 21	2 ⁷ / ₁₆	1 ¹ / ₂	15 to 22	2 ⁷ / ₁₆	2
	33 to 49	2 ⁷ / ₁₆	1 ¹ / ₂	21 to 37	2 ⁷ / ₁₆	1 ¹ / ₂	30 to 42	2 ⁷ / ₁₆	2	22 to 33	2 ⁷ / ₁₆	2	23 to 32	2 ⁷ / ₁₆	3
	50 to 56	2 ¹⁵ / ₁₆	1 ¹ / ₂	38 to 44	2 ⁷ / ₁₆	2	43 to 71	2 ¹⁵ / ₁₆	3	34 to 38	2 ⁷ / ₁₆	3	33 to 39	2 ¹⁵ / ₁₆	3
	57 to 80	2 ¹⁵ / ₁₆	2	45 to 54	2 ¹⁵ / ₁₆	2	72 to 83	2 ¹⁵ / ₁₆	5	39 to 55	2 ¹⁵ / ₁₆	3	40 to 69	2 ¹⁵ / ₁₆	5
	81 to 94	2 ¹⁵ / ₁₆	3	55 to 87	2 ¹⁵ / ₁₆	3	84 to 100	3 ⁷ / ₁₆	5	56 to 77	2 ¹⁵ / ₁₆	5	70 to 73	3 ⁷ / ₁₆	5
	95 to 100	3 ⁷ / ₁₆	3	88 to 100	3 ⁷ / ₁₆	5				78 to 100	3 ⁷ / ₁₆	5	74 to 100	3 ⁷ / ₁₆	7 ¹ / ₂
770	Up to 13	1 ¹⁵ / ₁₆	1	Up to 10	2 ⁷ / ₁₆	1	Up to 17	2 ⁷ / ₁₆	1 ¹ / ₂	Up to 11	2 ⁷ / ₁₆	1 ¹ / ₂	Up to 12	2 ⁷ / ₁₆	2
771	14 to 19	2 ⁷ / ₁₆	1	11 to 22	2 ⁷ / ₁₆	1 ¹ / ₂	18 to 27	2 ⁷ / ₁₆	2	12 to 19	2 ⁷ / ₁₆	2	13 to 19	2 ⁷ / ₁₆	3
	20 to 37	2 ⁷ / ₁₆	1 ¹ / ₂	23 to 35	2 ⁷ / ₁₆	2	28 to 33	2 ⁷ / ₁₆	3	20 to 27	2 ⁷ / ₁₆	3	20 to 24	2 ¹⁵ / ₁₆	3
	38 to 45	2 ⁷ / ₁₆	2	36 to 60	2 ¹⁵ / ₁₆	3	34 to 48	2 ¹⁵ / ₁₆	3	28 to 36	2 ¹⁵ / ₁₆	3	25 to 49	2 ¹⁵ / ₁₆	5
	46 to 54	2 ¹⁵ / ₁₆	2	61 to 81	2 ¹⁵ / ₁₆	5	49 to 75	2 ¹⁵ / ₁₆	5	37 to 67	2 ¹⁵ / ₁₆	5	50 to 55	2 ¹⁵ / ₁₆	7 ¹ / ₂
	55 to 90	2 ¹⁵ / ₁₆	3	82 to 100	3 ⁷ / ₁₆	5	76 to 89	3 ⁷ / ₁₆	5	68 to 100	3 ⁷ / ₁₆	7 ¹ / ₂	56 to 80	3 ⁷ / ₁₆	7 ¹ / ₂
	91 to 100	3 ⁷ / ₁₆	5				90 to 100	3 ⁷ / ₁₆	7 ¹ / ₂				81 to 100	3 ⁷ / ₁₆	10
776	Up to 20	2 ⁷ / ₁₆	1 ¹ / ₂	Up to 11	2 ⁷ / ₁₆	1 ¹ / ₂	Up to 14	2 ⁷ / ₁₆	2	Up to 11	2 ⁷ / ₁₆	3	Up to 12	2 ¹⁵ / ₁₆	3
777	21 to 26	2 ⁷ / ₁₆	2	12 to 19	2 ⁷ / ₁₆	2	15 to 28	2 ¹⁵ / ₁₆	3	12 to 20	2 ¹⁵ / ₁₆	3	13 to 28	2 ¹⁵ / ₁₆	5
	27 to 32	2 ¹⁵ / ₁₆	2	20 to 35	2 ¹⁵ / ₁₆	3	29 to 44	2 ¹⁵ / ₁₆	5	21 to 38	2 ¹⁵ / ₁₆	5	29 to 49	3 ⁷ / ₁₆	7 ¹ / ₂
	33 to 55	2 ¹⁵ / ₁₆	3	36 to 49	2 ¹⁵ / ₁₆	5	45 to 55	3 ⁷ / ₁₆	5	39 to 69	3 ⁷ / ₁₆	7 ¹ / ₂	50 to 60	3 ⁷ / ₁₆	10
	56 to 58	2 ¹⁵ / ₁₆	5	50 to 68	3 ⁷ / ₁₆	5	56 to 82	3 ⁷ / ₁₆	7 ¹ / ₂	70 to 87	3 ¹⁵ / ₁₆	10	61 to 69	3 ¹⁵ / ₁₆	10
	59 to 100	3 ⁷ / ₁₆	5	69 to 89	3 ⁷ / ₁₆	7 ¹ / ₂	83 to 89	3 ¹⁵ / ₁₆	7 ¹ / ₂				70 to 72	3 ¹⁵ / ₁₆	15
				90 to 100	3 ¹⁵ / ₁₆	7 ¹ / ₂	90 to 98	3 ¹⁵ / ₁₆	10						
777							90 to 100	3 ¹⁵ / ₁₆	10	70 to 96	3 ¹⁵ / ₁₆	10	70 to 100	3 ¹⁵ / ₁₆	15
777										97 to 100	3 ¹⁵ / ₁₆	15			
781	Up to 11	2 ¹⁵ / ₁₆	1 ¹ / ₂	Up to 11	2 ¹⁵ / ₁₆	2	Up to 17	2 ¹⁵ / ₁₆	3	Up to 12	2 ¹⁵ / ₁₆	3	Up to 18	3 ⁷ / ₁₆	5
	12 to 20	2 ¹⁵ / ₁₆	2	12 to 23	2 ¹⁵ / ₁₆	3	18 to 23	2 ¹⁵ / ₁₆	5	13 to 17	2 ¹⁵ / ₁₆	5	19 to 31	3 ⁷ / ₁₆	7 ¹ / ₂
	21 to 35	2 ¹⁵ / ₁₆	3	24 to 28	2 ¹⁵ / ₁₆	5	24 to 38	3 ⁷ / ₁₆	5	18 to 28	3 ⁷ / ₁₆	5	32 to 48	3 ¹⁵ / ₁₆	10
	36 to 66	3 ⁷ / ₁₆	5	29 to 47	3 ⁷ / ₁₆	5	39 to 50	3 ⁷ / ₁₆	7 ¹ / ₂	29 to 42	3 ⁷ / ₁₆	7 ¹ / ₂	49 to 60	3 ¹⁵ / ₁₆	15
	67 to 72	3 ¹⁵ / ₁₆	5	48 to 56	3 ⁷ / ₁₆	7 ¹ / ₂	51 to 63	3 ¹⁵ / ₁₆	7 ¹ / ₂	43 to 48	3 ¹⁵ / ₁₆	7 ¹ / ₂	61 to 79	4 ⁷ / ₁₆	15
	73 to 100	3 ¹⁵ / ₁₆	7 ¹ / ₂	57 to 77	3 ¹⁵ / ₁₆	7 ¹ / ₂	64 to 84	3 ¹⁵ / ₁₆	10	49 to 68	3 ¹⁵ / ₁₆	10	80 to 91	4 ⁷ / ₁₆	20
				78 to 92	3 ¹⁵ / ₁₆	10	85 to 100	4 ⁷ / ₁₆	15	69 to 74	3 ¹⁵ / ₁₆	15			
				93 to 100	4 ⁷ / ₁₆	10				75 to 100	4 ⁷ / ₁₆	15			
783	Up to 17	2 ¹⁵ / ₁₆	2	Up to 19	2 ¹⁵ / ₁₆	3	Up to 14	2 ¹⁵ / ₁₆	3	Up to 10	2 ¹⁵ / ₁₆	3	Up to 15	3 ⁷ / ₁₆	5
	18 to 28	2 ¹⁵ / ₁₆	3	20 to 41	3 ⁷ / ₁₆	5	15 to 32	3 ⁷ / ₁₆	5	11 to 24	3 ⁷ / ₁₆	5	16 to 22	3 ⁷ / ₁₆	7 ¹ / ₂
	29 to 32	3 ⁷ / ₁₆	3	42 to 45	3 ⁷ / ₁₆	7 ¹ / ₂	33 to 39	3 ⁷ / ₁₆	7 ¹ / ₂	25 to 32	3 ⁷ / ₁₆	7 ¹ / ₂	23 to 29	3 ¹⁵ / ₁₆	7 ¹ / ₂
	33 to 54	3 ⁷ / ₁₆	5	46 to 68	3 ¹⁵ / ₁₆	7 ¹ / ₂	40 to 55	3 ¹⁵ / ₁₆	7 ¹ / ₂	33 to 42	3 ¹⁵ / ₁₆	7 ¹ / ₂	30 to 42	3 ¹⁵ / ₁₆	10
	55 to 63	3 ¹⁵ / ₁₆	5	69 to 76	3 ¹⁵ / ₁₆	10	56 to 69	3 ¹⁵ / ₁₆	10	43 to 59	3 ¹⁵ / ₁₆	10	43 to 69	4 ⁷ / ₁₆	15
	64 to 88	3 ¹⁵ / ₁₆	7 ¹ / ₂	77 to 95	4 ⁷ / ₁₆	10	70 to 77	4 ⁷ / ₁₆	10	60 to 96	4 ⁷ / ₁₆	15	70 to 79	4 ⁷ / ₁₆	20
	89 to 100	4 ⁷ / ₁₆	7 ¹ / ₂	96 to 100	4 ⁷ / ₁₆	15	78 to 100	4 ⁷ / ₁₆	15						

Type 7-Chain ■

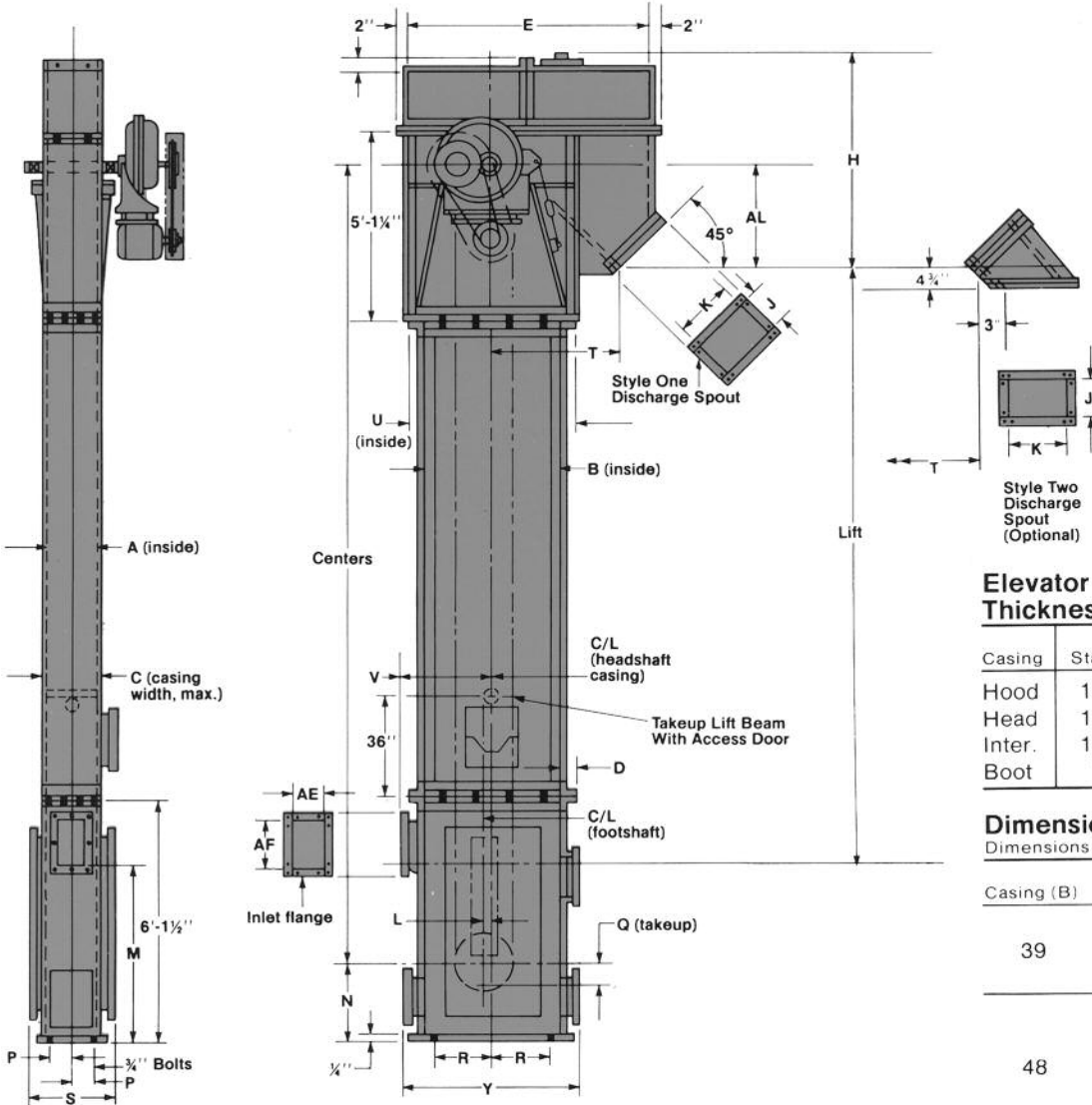

Elevator Casing Thicknesses

Casing	Standard	Heavy-Duty	Extra Heavy-Duty
Hood	14 Ga.	12 Ga.	12 Ga.
Head	12 Ga.	10 Ga.	7 Ga.
Inter.	12 Ga.	10 Ga.	7 Ga.
Boot	7 Ga.	7 Ga.	¼"

Dimension AL

Dimensions in inches

Casing (B)	Shaft (Dia.)	Ball Bearing	Roller Bearing
39	1 ¹ / ₁₆	34½	34½
	2 ⁷ / ₁₆	34 ⁵ / ₁₆	35
	2 ¹⁵ / ₁₆	35½	35½
48	1 ¹ / ₁₆	35¾	35¾
	2 ⁷ / ₁₆	36 ³ / ₁₆	36¾
	2 ¹⁵ / ₁₆	36¾	36¾
	3 ⁷ / ₁₆	37¼	37¼
	3 ¹⁵ / ₁₆	37 ¹⁵ / ₁₆	37¾

Dimensions in inches

Elevator Number	Casing Size A x B	C	D	E	H	J	K	L	▲ M	N	P	Q	R	S	T	U	V	Y	AE	AF
766,767	11¾ x 39	16 ³ / ₈	1½	57¼	59¼	11 ¹ / ₈	13	3	40½	20½	7¾	6	16½	19¾	27	42	22½	46½	6	12
768,769	13¾ x 39	18 ³ / ₈	1½	57¼	59¼	13 ³ / ₈	13	3	40½	20½	8¾	6	16½	21¾	27	42	22½	46½	8	12
770,771	13¾ x 48	18½	2	72	67	13 ³ / ₈	17	3	52½	27	8¾	8	21	21¾	33	54	27	55½	8	15
776,777	15¾ x 48	20 ³ / ₈	2	72	67	15 ³ / ₈	17	3	52½	27	9¾	8	21	23¾	33	54	27	55½	10	15
781	19¾ x 48	24 ³ / ₈	2	72	67	19 ³ / ₈	17	3	54½	29	11¾	10	21	27¾	33	54	27	55½	14	15
783	21¾ x 48	26 ³ / ₈	2	72	67	21 ³ / ₈	17	3	54½	29	12¾	10	21	29¾	33	54	27	55½	16	15

○ For 10 and 12 gauge discharge spout. Deduct ½" for 7 gauge discharge spout.

▲ Minimum dimension for efficient loading.

■ Dimensions should not be used for Type 8 Elevators. Consult Syntron Material Handling for dimensional data.

Service Platforms

Standard service platforms with ladders and safety cages are available for all Link-Belt® Bucket Elevators. Platforms provide ready access to drives and head terminals for inspection and lubrication.

Each platform is manufactured to best accommodate the bucket elevator installation. Service platforms, supported by the elevator casing, extend around three sides of the elevator.

Safety cages are recommended for all ladders.

In accordance with OSHA requirements, when ladders with cages exceed 30 feet in height, intermediate landing platforms shall be provided for each 30 feet of height or fraction thereof.

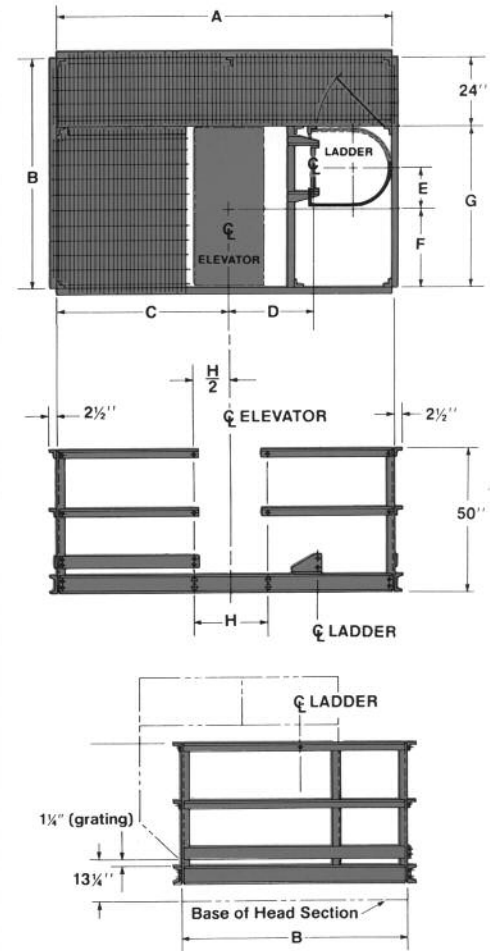
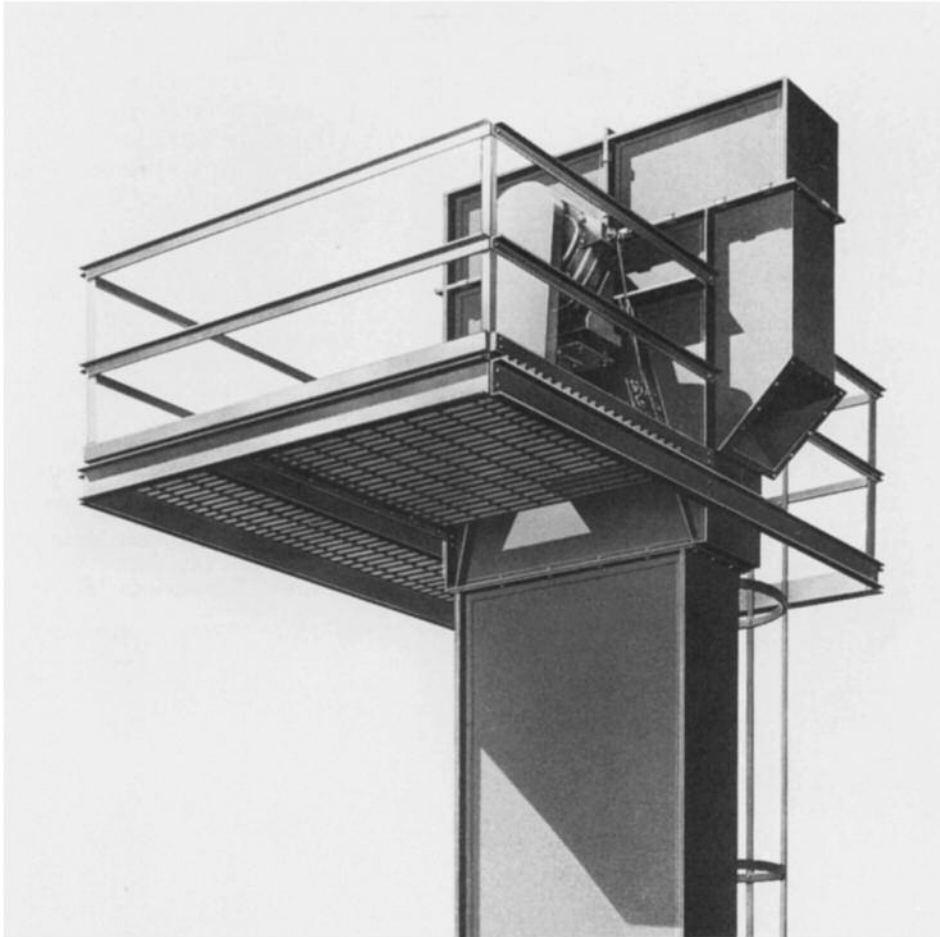

Dimensions in inches

Casing Size	Part Number	Assembly Weight Lbs.	A	B	C	D	E	F	G	H
9 3/4 x 35	116-130-FA	1155	108 1/4	68 1/4	54	27	3	23	44 1/4	12 5/8
11 1/4 x 35	116-130-FB	1149	108 1/4	68 1/4	54	27	3	23	44 1/4	14 1/8
11 1/4 x 39	116-130-FC	1149	108 1/4	68 1/4	54	27	5	23	44 1/4	14 1/8
13 1/4 x 39	116-130-FD	1143	108 1/4	68 1/4	54	27	5	23	44 1/4	16 1/8
11 1/4 x 42	116-130-FF	1149	108 1/4	68 1/4	54	27	6 1/2	23	44 1/4	14 1/8
13 1/4 x 42	116-130-FG	1143	108 1/4	68 1/4	54	27	6 1/2	23	44 1/4	16 1/8
13 1/4 x 48	116-130-FJ	1300	117 1/4	80 1/4	60	30 1/2	9 1/2	29	56 1/4	16 1/8
15 1/4 x 48	116-130-FK	1293	117 1/4	80 1/4	60	30 1/2	9 1/2	29	56 1/4	18 1/8
19 1/4 x 48	116-130-FM	1281	117 1/4	80 1/4	60	30 1/2	9 1/2	29	56 1/4	22 1/8
21 1/4 x 48	116-130-FN	1274	117 1/4	80 1/4	60	30 1/2	9 1/2	29	56 1/4	24 1/8
17 1/4 x 54	116-130-FR	1287	117 1/4	80 1/4	60	30 1/2	12 1/2	29	56 1/4	20 1/8
19 1/4 x 54	116-130-FS	1281	117 1/4	80 1/4	60	30 1/2	12 1/2	29	56 1/4	22 1/8
22 1/4 x 54	116-130-FT	1271	117 1/4	80 1/4	60	30 1/2	12 1/2	29	56 1/4	25 1/8

Link-Belt® Standard Components... developed as integral parts of rugged and dependable Bucket Elevators

Link-Belt® Type 1 and Type 7 Bucket Elevator designs are standardized so you benefit from the economics of many stocked components.

A balanced design of components and manufacturing craftsmanship assure efficient operation of every Link-Belt® Bucket Elevator.

Chains - Steel Bushed Chain recommended for heavy-duty service. Combination Chain is available for light to medium-duty service.

Elevator Belt- Maximum resistance to the most common forms of abuse damage.

Pulleys - Precision assembly of carefully manufactured parts. Built to rigid standards to assure longer belt life.

Sprockets - Available in solid, split or segmental rim types with smooth, wear-resisting file-hard bearing surfaces.

Internal Gravity Takeups - Rugged steel frame, durable bearings, and hardened steel shafting assure trouble-free operation.

Drives - A product of experience with unmatched reliability.

Elevator Buckets - Style AA for centrifugal discharge elevators and Style MF for continuous discharge elevators-A style for all types of bulk material.

Bearings - A wide selection to meet all conditions encountered in bucket elevator operation.



Bucket Elevators... a range of models suitable for many requirements.

In addition to the Type 1 and Type 7 Link-Belt® Bucket Elevators described in this catalog, Syntron Material Handling has available a range of types and styles... designed to handle even the most difficult

bulk material elevating requirements. Information is available by contacting our application specialist at 800.356.4899.



Bucket Elevator	Material Applications
Type 6	Light, fluffy or fragile. Material with tendency to adhere to the buckets. Low bucket speed.
Type 10	Friable, heavy or abrasive-fines to large lumps. Super capacity.
Type 12	Free-flowing nonabrasive- slow speed. Gentle handling.
Type 13	Free-flowing nonabrasive- higher speed and capacity than Type 12. Gentle handling.
Type 14	Abrasive - cement, shale, bauxite, gypsum etc....
Type 15	Abrasive- feldspar, gravel, sand, clinker etc.... greater capacity than Type 14.

Link-Belt® Elevator Buckets

For Centrifugal Discharge and Continuous Bucket Elevators.

Link-Belt® Elevator Buckets are designed in a variety of types and sizes to efficiently handle bulk materials in centrifugal discharge and continuous bucket elevators. Buckets are either constructed of formed steel, cast, or molded with nylon or polyethylene. Cast buckets are available in ductile iron, Promal, or ductile iron with Flint-Lip hardened digging lips.

Ductile iron is the most commonly used material in cast buckets because of its ability to withstand the effects of abrasion and stresses during digging.

Promal is a pearlitic malleable with higher tensile and fatigue strength and yield point than ductile iron. Promal also has a greater resistance to abrasive wear.

Ductile iron elevator buckets with Flint-Lip provide increased wear life when handling abrasive materials. Elevator buckets can also be furnished in mild steel, abrasion-resistant steel, stainless steel and aluminum.

Type AA and MF can be supplied in either nylon or polyethylene. Centrifugal Discharge Elevator Buckets are used for handling granular, freeflowing materials

which can be readily scooped up and discharged easily by centrifugal action as the buckets pass over the elevator head wheel.

When higher capacities at lower speeds are desired, or when the material being handled is friable and fragile, Continuous Elevator Buckets are used. Material is fed directly into the bucket and is discharged over the elevator head wheel onto the preceding bucket which acts as a chute, providing a clean, gentle discharge.

Elevator Bucket Types

Type AA Centrifugal Discharge Elevator Buckets are made of ductile iron or Promal for mounting on chains or belts. They have a thick, wide reinforced lip along the front edge and front corners for resistance to distortion when scooping up heavy or gritty materials. For increased wear life when handling abrasive materials, buckets can be furnished when hardened lips.

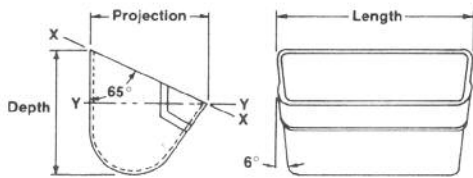

Type AAW Centrifugal Discharge Elevator Buckets are identical with Type AA buckets, except they are available in mild steel, abrasion-resistant steel or stainless steel.

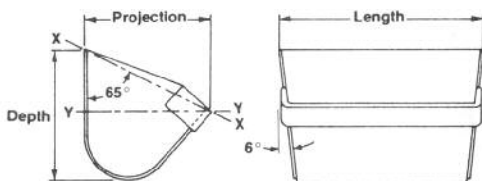

Have dimensions certified for installation purposes.

★ Boldface type indicates unpunched ductile iron buckets normally carried in stock. Buckets made of Promal, ductile iron with hardened lip, or ductile iron with galvanized protective coating can be furnished.

▲ Actual capacity depends on angle of repose of material handled.

Type AA Elevator Buckets

Bucket size, inches ★			Weight pounds	Capacity cubic feet ▲	
Length	Projection	Depth		Filled to line X-X	Filled to line Y-Y
6	4	4¼	2.7	.03	.018
8	5	5½	4.6	.07	.042
10	6	6¼	7.7	.12	.072
12	6	6¼	9.4	.14	.084
12	7	7¼	11.5	.19	.114
14	7	7¼	14.7	.23	.138
14	8	8½	18.5	.30	.180
16	8	8½	20.9	.34	.204
18	10	10½	35.0	.61	.366
24	8	8½	30.5	.51	.306

Type AAW Elevator Buckets

Bucket size, inches ★			Weight pounds	Capacity cubic feet ▲	
Length	Projection	Depth		Filled to line X-X	Filled to line Y-Y
9	6	6½	6.7	.095	.057
10	6	6½	7.3	.12	.072
12	6	6½	8.4	.14	.084
12	7	7 ⁵ / ₈	13.3	.19	.114
14	7	7 ⁵ / ₈	14.9	.23	.138
14	8	7 ⁵ / ₈	16.6	.30	.180
16	7	8 ¹ / ₁₆	17.4	.27	.162
16	8	8 ¹ / ₁₆	19.4	.34	.204
18	8	8 ¹ / ₁₆	21.3	.39	.234
20	8	8 ¹ / ₁₆	23.2	.43	.258
24	8	8 ¹ / ₁₆	27.1	.61	.306

Link-Belt® Elevator Buckets

Type AA Plastic Centrifugal Disch Elevator Buckets are identical to type AA except are available in "Super Tuff" nylon or polyethelene for food grade.

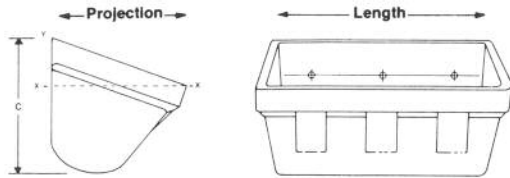

Type AA-RB Centrifugal Discharge Elevator Buckets are made of ductile iron or Promal and are identical with Type AA buckets, except the back edges are thicker to provide greater resistance to distortion. The wide digging lip and vertical reinforcing ribs on the front enable these buckets to withstand rough service. For increased wear life when handling abrasive materials, buckets can be furnished with hardened lips.

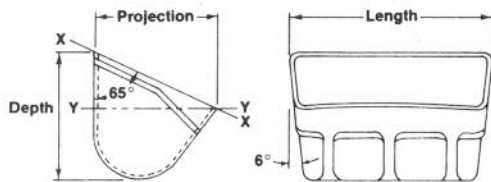

Type SC Centrifugal Discharge Elevator Buckets are made of ductile iron for mounting on chains or belts. They are suitable for handling dry or relatively wet materials at greater capacities than Type AA buckets. The buckets are smooth, seamless and uniformly cast to resist abrasive wear, corrosion and rust.

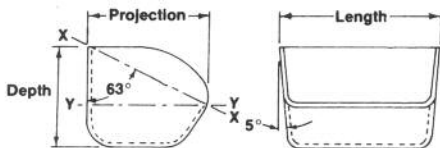

Have dimensions certified for installation purposes.

★ Boldface type indicates unpunched ductile iron buckets normally carried in stock. Buckets made of Promal, ductile iron with hardened lip, or ductile iron with galvanized protective coating can be furnished.

▲ Actual capacity depends on angle of repose of material handled.

Industrial Duty AA Nylon Buckets

Bucket size, inches ★			Weight pounds	Capacity cubic inches ▲	
Length	Projection	Depth		Filled to line X-X	Filled to line X-Y
4¼	3⅞	3⅞	.25	13.4	15.9
5¼	4⅞	4⅞	.52	34.8	45.2
6¼	4⅞	4⅞	.59	41.5	54.3
7¼	4⅞	4⅞	.66	51.3	65.3
7⅞	5⅞	5¼	.97	76.6	94.6
8⅞	5⅞	5¼	1.10	89.7	111.7
9⅞	5⅞	5¼	1.18	101.3	122.0
9⅞	6⅞	6⅞	1.48	132.4	170.9
10⅞	6⅞	6⅞	1.61	148.3	191.6
11⅞	6⅞	6⅞	1.70	163.5	209.3
12⅞	6⅞	6⅞	2.16	186.1	248.1
12⅞	7⅞	7⅞	2.50	244.1	320.4
14⅞	7⅞	7⅞	3.00	298.4	384.4
14⅞	8⅞	8⅞	4.25	351.5	463.8
16⅞	8⅞	8⅞	4.75	406.4	540.1
18⅞	8⅞	8⅞	5.10	467.4	619.4
18½	10⅞	10⅞	8.10	692.6	915.3

Type AA-RB Elevator Buckets

Bucket size, inches ★			Weight pounds	Capacity cubic feet ▲	
Length	Projection	Depth		Filled to line X-X	Filled to line Y-Y
8	5	5½	5.0	.070	.042
10	6	6¼	8.0	.120	.072
11	6	6¼	9.6	.130	.078
12	6	6¼	10.4	.140	.084
12	7	7¼	13.8	.190	.114
14	7	7¼	16.5	.230	.138
14	8	8½	22.0	.300	.180
16	7	7¼	18.5	.270	.162
16	8	8½	26.0	.340	.204
18	8	8½	30.0	.390	.230

Type SC Elevator Buckets

Bucket size, inches ★			Weight pounds	Capacity cubic feet ▲
Length	Projection	Depth		Filled to line X-X
8	6	5	5.6	.086
10	8	7	11.8	.180
12	8	7	14.2	.230
14	8	7	17.9	.269
16	8	7	18.9	.300

Link-Belt® Elevator Buckets

Type AC Centrifugal Discharge Elevator Buckets are made of ductile iron or Promal for mounting on chain. They have a thick, wide reinforced lip along the front edge and front corners to increase resistance to distortion. The high front increases capacity, and hooded backs permits closer bucket spacing. Air-pressure relief holes in the bottom of the buckets assure faster loading and unloading of free-flowing materials, such as cement. For increased wear life when handling abrasive materials, buckets can be furnished with hardened lips.

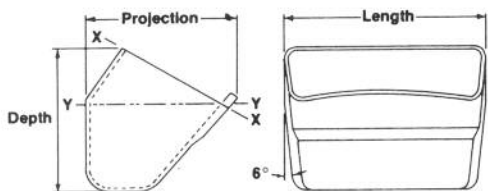

Type ACS Centrifugal Discharge Elevator Buckets are made of mild steel or aluminum for mounting on chain. Their high front and the saddlebag or wraparound feature increases capacity, while the hooded backs permit closer bucket spacing. For increased wear life when handling abrasive materials, buckets can be furnished with hardened lips.

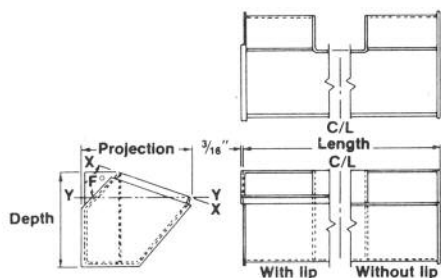

Type HFO Continuous Elevator Buckets are made of welded steel for mounting on chains or belts. They have the same high front as Type HF buckets, but in addition, are overlapping to prevent leakage between buckets. Bevel washers are recommended to avoid interference of adjacent buckets. The smooth interior allows the material to be easily and quickly discharged. Buckets are of formed and welded steel construction. The front plates are either intermittent or continuous welded to the back and side plates, depending on the fineness of the material being handled.

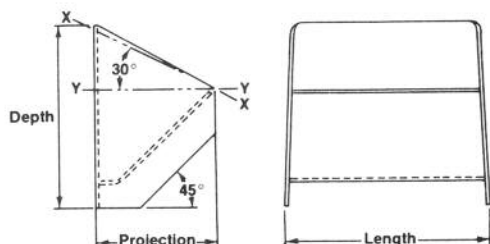

Have dimensions certified for installation purposes.

▲ Actual capacity depends on angle of repose of material handled.

Type AC Elevator Buckets

Bucket size, inches ★			Weight pounds	Capacity cubic inches ▲	
Length	Projection	Depth		Filled to line X-X	Filled to line X-Y
12	8	8 ⁷ / ₈	28.0	.28	.21
16	8	8 ⁷ / ₈	34.0	.38	.28
18	10	11	52.0	.62	.49
24	10	11	72.0	.85	.68

Type ACS Elevator Buckets

Bucket size, inches			F°	Weight, pounds		Capacity cubic feet ▲		
Length	Projection	Depth		steel	aluminum	Filled to line X-X	Filled to line Y-Y	
14	12	11 ³ / ₈	26	36	32	15.3	.53	.37
16	12	11 ³ / ₈	26	39	35	17.2	.62	.44
18	12	11 ³ / ₈	26	42	37	19.0	.71	.51
21	14	13 ³ / ₈	28	56	51	25.3	1.08	.78
24	14	13 ³ / ₈	28	62	56	27.3	1.28	.93
27	15	13 ³ / ₈	21	72	--	32.3	1.62	1.29
30	15	13 ³ / ₈	21	84	--	37.3	1.84	1.47

Type HFO Elevator Buckets

Bucket size, inches			Weight, pounds					Capacity cubic feet ▲	
Length	Projection	Depth	14 gauge steel	12 gauge steel	10 gauge steel	3/16" steel	1/4" steel	Filled to line X-X	Filled to line Y-Y
8	5	8 ¹ / ₂	3.7	5.1	6.5	8.9	---	.089	.059
10	5	8 ¹ / ₂	4.3	5.9	7.6	10.5	---	.112	.077
10	6	10	---	7.5	9.5	13.1	---	.162	.108
10	7	12 ¹ / ₂	---	9.6	12.3	16.7	---	.227	.150
12	6	10	---	8.6	10.8	15.0	---	.193	.126
12	7	12 ¹ / ₂	---	10.8	14.0	19.0	---	.275	.182
12	8	12 ¹ / ₂	---	11.8	15.0	20.5	27.1	.320	.200
14	7	12 ¹ / ₂	---	12.1	15.7	21.3	---	.333	.224
14	8	12 ¹ / ₂	---	13.1	16.8	22.9	30.4	.386	.246
16	8	12 ¹ / ₂	---	14.5	18.6	25.2	33.6	.425	.265
16	12	18 ⁵ / ₈	---	---	31.1	43.0	56.8	.962	.605
20	12	18 ⁵ / ₈	---	---	36.4	50.4	66.6	1.203	.755
24	12	18 ⁵ / ₈	---	---	41.7	57.8	76.4	1.444	.905

Link-Belt® Elevator Buckets

Type HF Continuous Elevator Buckets are made of welded steel for mounting on chains or belts. They have high fronts and are proportioned for high capacity. The smooth interior allows the material to be easily and quickly discharged. Buckets are of formed and welded steel construction. The front plates are either intermittent or continuous welded to the back and side plates, depending on the fineness of the material being handled.

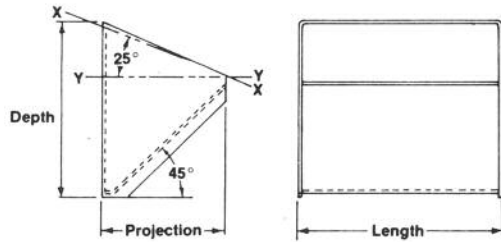

Super Capacity Continuous Elevator Buckets are made of welded steel for mounting between two strands of chain. They are normally used on super-capacity type continuous bucket elevators. The smooth interior permits a quick, clean discharge of material. The front and bottom plates are either intermittent or continuous welded to the back and side plates, depending on the fineness of the material being handled.

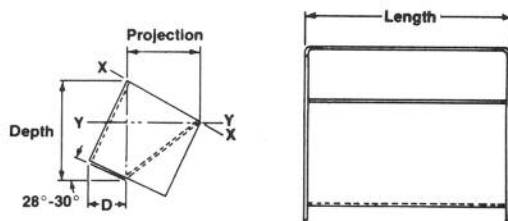

Type LF Continuous Elevator Buckets are made of welded steel for mounted on chains or belts. They have low fronts and are designed for inclined bucket elevators or to handle finely pulverized or wet materials. Buckets are of formed and welded steel construction. The front plates are either intermittent or continuous welded to the back and side plates, depending on the fineness of the material being handled.

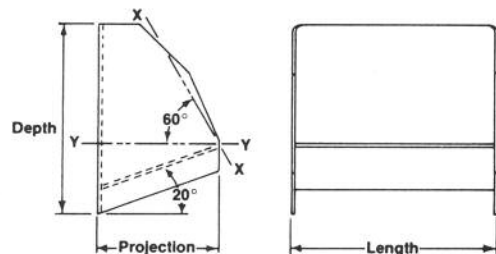

Have dimensions certified for installation purposes.
▲ Actual capacity depends on angle of repose of material handled.

Type HF Elevator Bucket

Bucket size, inches			Weight, pounds					Capacity cubic feet ▲	
Length	Projection	Depth	14 gauge steel	12 gauge steel	10 gauge steel	3/16" steel	1/4" steel	Filled to line X-X	Filled to line Y-Y
8	5	7 3/4	3.5	4.9	6.2	8.5	---	.080	.052
10	5	7 3/4	4.1	5.7	7.3	10.0	---	.100	.065
10	6	9 1/4	---	7.2	9.1	12.6	---	.145	.098
10	7	11 5/8	---	9.1	11.6	16.0	20.9	.190	.130
12	6	9 1/4	---	8.3	10.4	14.4	---	.175	.115
12	7	11 5/8	---	10.3	13.2	18.2	23.9	.240	.155
12	8	11 5/8	---	11.3	14.3	20.0	26.0	.295	.205
14	7	11 5/8	---	11.5	14.8	20.4	26.7	.280	.184
14	8	11 5/8	---	12.6	16.0	22.4	28.1	.350	.240
16	8	11 5/8	---	13.9	17.7	24.7	32.2	.395	.275
16	12	17 5/8	---	---	30.3	41.9	55.0	.900	.635
18	10	15	---	---	26.2	36.1	47.7	.720	.485
20	12	17 5/8	---	---	35.1	49.1	64.6	1.150	.800
24	12	17 5/8	---	---	40.5	56.3	74.3	1.335	.960

Super Capacity Elevator Buckets

Bucket size, inches			D inches	Weight, pounds				Capacity cubic feet ▲	
Length	Projection	Depth		10 gauge steel	3/16" steel	1/4" steel	5/16" steel	Filled to line X-X	Filled to line Y-Y
12	8 3/4	11 5/8	4 9/16	22	29	39	49	.54	.35
14	8 3/4	11 5/8	4 9/16	23	31	41	51	.63	.41
16	8 3/4	11 5/8	4 9/16	25	34	45	56	.72	.46
16	12 7/16	17 3/8	6 1/2	43	58	76	95	1.55	1.11
18	8 3/4	11 5/8	4 9/16	27	36	48	60	.81	.52
20	8 3/4	11 5/8	4 9/16	29	39	52	65	.90	.58
20	12 7/16	17 3/8	6 1/2	49	67	88	110	1.94	1.40
24	12 7/16	17 3/8	6 1/2	55	75	104	130	2.33	1.68
30	12 7/16	17 3/8	6 1/2	65	88	117	146	2.91	2.11
36	12 7/16	17 3/8	6 1/2	73	99	132	165	3.49	2.53

Type LF Elevator Buckets

Bucket size, inches			Weight, pounds				Capacity cubic feet ▲	
Length	Projection	Depth	12 gauge steel	10 gauge steel	3/16" steel	1/4" steel	Filled to line X-X	Filled to line Y-Y
10	6	9 1/4	6.8	8.8	12.1	---	.168	.035
10	7	11 5/8	8.5	10.8	15.1	---	.242	.050
12	6	9 1/4	7.8	10.0	13.8	---	.201	.042
12	7	11 5/8	9.6	12.3	17.1	---	.302	.060
12	8	11 5/8	11.2	14.4	20.1	---	.347	.075
14	7	11 5/8	10.7	13.7	19.1	---	.345	.070
16	8	11 5/8	13.6	17.4	24.3	---	.463	.101
16	12	17 5/8	---	29.3	40.7	53.6	1.093	.229
18	10	15	---	25.4	35.0	46.5	.940	.183
20	8	11 5/8	15.9	20.5	28.5	---	.573	.126
20	12	17 5/8	---	33.9	47.1	62.0	1.365	.287
24	12	17 5/8	---	38.5	53.5	70.5	1.643	.346

Link-Belt® Elevator Buckets

Type MF Continuous Elevator Buckets are made of welded steel for mounting on chains or belts. They have medium fronts and are used for handling a variety of materials. The smooth interior provides a quick, clean discharge of material. Buckets are of formed and welded steel construction. The front plates are either intermittent or continuous welded to the back and side plates, depending on the fineness of the material being handled.

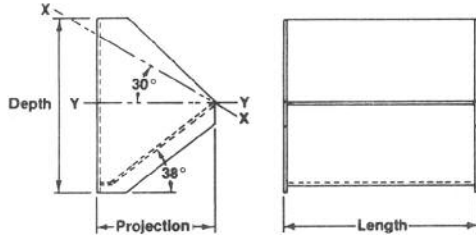

Type MF "Plastic" Continuous Elevator Buckets are identical to MF except are available in "Super Tuff" nylon or polyethelene for food grade applications.

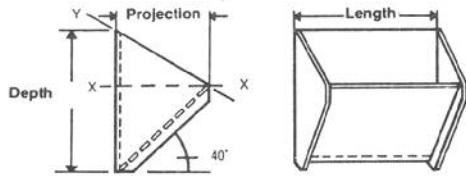

Have dimensions certified for installation purposes.

▲ Actual capacity depends on angle of repose of material handled.

Type MF Elevator Buckets

Bucket size, inches			Weight, pounds				Capacity cubic feet ▲	
Length	Projection	Depth	12 gauge steel	10 gauge steel	3/16" steel	1/4" steel	Filled to line X-X	Filled to line Y-Y
8	5	7 3/4	5.1	6.3	8.7	---	.070	.040
9	6	9 1/4	6.7	8.6	11.9	---	.118	.068
10	5	7 3/4	5.9	7.4	10.2	---	.090	.050
10	6	9 1/4	7.2	9.2	12.7	---	.130	.075
10	7	11 5/8	9.3	11.9	16.5	---	.180	.103
10	8	11 5/8	9.9	12.8	17.8	23.2	.235	.135
11	6	9 1/4	7.7	9.9	13.6	---	.145	.081
12	6	9 1/4	8.1	10.5	14.5	---	.155	.091
12	7	11 5/8	10.4	13.4	18.6	---	.218	.125
12	8	11 5/8	11.2	14.4	20.0	26.1	.275	.163
14	7	11 5/8	11.6	14.9	20.7	---	.253	.145
14	8	11 5/8	12.4	16.0	22.2	29.1	.325	.190
16	8	11 5/8	13.7	17.6	24.5	32.0	.375	.220
16	12	17 5/8	---	29.9	40.6	54.8	.852	.490
18	8	11 5/8	14.9	19.2	26.7	35.0	.420	.250
18	10	15	---	25.9	36.1	47.3	.662	.379
20	8	11 5/8	16.1	20.8	29.0	38.0	.470	.270
20	12	17 5/8	---	34.8	48.5	63.9	1.075	.620
24	10	11 5/8	---	27.4	38.2	50.0	.850	.512
24	12	17 5/8	---	39.8	55.4	73.1	1.295	.745

Medium Front Continuous Discharge Elevator Bucket

Bucket size			Weight pounds	Capacity cubic inches ▲	
Length A	Projection B*	Depth C		Water Level X-X	100% Gross X-Y
8 1/4	5 1/2	7 1/2	1.95	80.56	122.06
10 1/4	5 1/2	7 1/2	2.35	94.90	144.64
12 1/4	8 1/2	11 3/4	4.95	274.60	462.53
14 1/4	8 1/2	11 3/4	5.22	335.61	554.67
16 1/4	8 1/2	11 3/4	5.76	396.63	646.81
18 1/4	8 1/2	11 3/4	6.68	467.65	738.95

Elevator Bolts

Elevator Bolts are made to ANSI specifications and are held to exacting tolerances. We offer our SABRE-TOOTH HEAD® in carbon steel only.

Elevator bolts are "Low Shoulder" design to accommodate requirements for use on today's ultra-thin belting.

Plain finish and zinc plated carbon steel in stock.

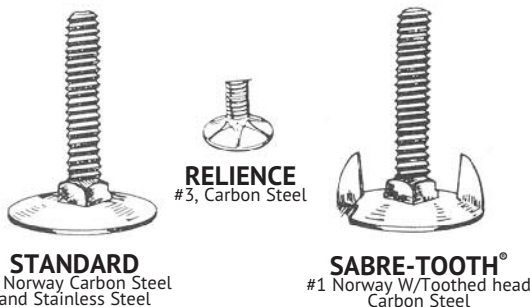

STANDARD and SABRE-TOOTH®

SIZE	WEIGHT PER 100 PCS., LBS.
1/4" x 3/4"	2.94 lbs.
1/4" x 1"	3.24 lbs.
1/4" x 1 1/4"	3.43 lbs.
1/4" x 1 1/2"	3.73 lbs.
1/4" x 2"	4.29 lbs.
1/4" x 2 1/2"	4.92 lbs.
5/16" x 3/4"	4.76 lbs.
5/16" x 1"	5.05 lbs.
5/16" x 1 1/4"	5.55 lbs.
5/16" x 1 1/2"	6.38 lbs.
5/16" x 2"	7.12 lbs.
5/16" x 2 1/2"	7.78 lbs.
3/8" x 1 1/2"	8.80 lbs.
3/8" x 2"	9.92 lbs.
3/8" x 2 1/2"	10.00 lbs.

RELIANCE

SIZE	WEIGHT PER 100 PCS., LBS.
1/4" x 3/4"	2.7
1/4" x 1"	2.9
1/4" x 1 1/4"	3.0
5/16" x 1 1/4"	4.9

Bucket Punching for Chains

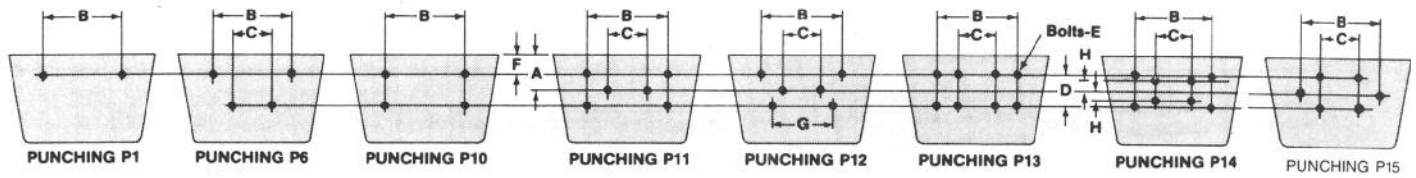

Centrifugal Discharge Elevator Buckets on K Attachments

Chain attachment number	Nominal bucket size, inches						Punching	A	B	C	D	E	F
	Types AA, AA-RB		Type AC		Type SC								
	Min.	Max.	Min.	Max.	Min.	Max.							
SS 39-K1	6x4	12x6	---	---	8x6	12x8	P1	---	3 ³ / ₄	---	---	1/2	1 1/2
SS 39-K2	6x4	12x6	---	---	8x6	12x8	P10	---	3 ³¹ / ₃₂	---	17/8	5/16	7/8
42-K1	6x4	6x4	---	---	---	---	P1	---	2	---	---	3/16	1/2
45-K1	6x4	6x4	---	---	---	---	P1	---	2	---	---	3/16	1/2
52-K1	6x4	8x5	---	---	8x6	8x6	P1	---	2 ³ / ₈	---	---	3/16	1/2
55-K1	6x4	6x4	---	---	---	---	P1	---	2	---	---	3/16	1/2
C55-K1	6x4	6x4	---	---	---	---	P1	---	2	---	---	1/4	1/2
57-K1	6x4	10x6	---	---	8x6	10x8	P1	---	3	---	---	1/4	1/2
C 60-K1	6x4	10x6	---	---	8x6	10x8	P1	---	3	---	---	5/16	3/4
H 60-K1	6x4	10x6	---	---	8x6	10x8	P1	---	3	---	---	5/16	3/4
62-K1*	6x4	8x5	---	---	8x6	8x6	P1	---	2 ³ / ₈	---	---	1/4	1
67-K1	6x4	10x6	---	---	8x6	10x8	P1	---	3	---	---	1/4	1
H 74-K1	6x4	10x6	---	---	8x6	10x8	P1	---	2 ⁷ / ₈	---	---	5/16	3/4
75-K1	6x4	10x6	---	---	8x6	10x8	P1	---	2 ¹³ / ₁₆	---	---	1/4	1
H 75-K1	6x4	10x6	---	---	8x6	10x8	P1	---	2 ¹³ / ₁₆	---	---	5/16	1
77-K1	6x4	10x6	---	---	8x6	10x8	P1	---	3	---	---	1/4	1
77-K2	6x4	10x6	---	---	8x6	10x8	P10	---	3	---	1 ³ / ₁₆	1/4	1
C 77-K1	6x4	10x6	---	---	8x6	10x8	P1	---	3	---	---	3/8	1
78-K1	6x4	10x6	---	---	8x6	10x8	P1	---	3 ³ / ₈	---	---	1/4	3/4
H 78-K1	6x4	12x6	---	---	8x6	12x8	P1	---	4	---	---	3/8	1
H-78-K2	6x4	12x6	---	---	8x6	12x8	P10	---	4	---	1 ¹ / ₈	3/8	5/8
H 79-K1	6x4	12x6	---	---	8x6	12x8	P1	---	4	---	---	3/8	1
H 82-K1	8x5	12x6	---	---	8x6	12x8	P1	---	4 ³ / ₁₆	---	---	3/8	1
H 82-K2	8x5	14x7	---	---	8x6	14x8	P10	---	4 ¹ / ₄	---	1 ⁵ / ₁₆	3/8	3/4
88-K1	6x4	12x6	---	---	8x6	12x8	P1	---	3 ¹³ / ₁₆	---	---	5/16	3/4
95-K2	8x5	16x7	---	---	8x6	16x8	P10	---	5 ³ / ₁₆	---	1 ³ / ₄	3/8	3/4
SS 96-K2	10x6	14x8	---	---	10x8	14x8	P10	---	4 ³ / ₈	---	3	1/2	1 ³ / ₈
C 102B-K2	8x5	16x7	---	---	8x6	16x8	P10	---	5 ⁵ / ₁₆	---	1 ³ / ₄	3/8	3/4
SS 102B-K2	7x4 ¹ / ₂	16x7	---	---	8x6	16x8	P10	---	5 ⁵ / ₁₆	---	1 ³ / ₄	3/8	3/4
C 102 1/2-K2	8x5	16x7	---	---	8x6	16x8	P10	---	5 ⁵ / ₁₆	---	1 ³ / ₄	1/2	3/4
SS 102 1/2-K2	8x5	16x7	---	---	8x6	16x8	P10	---	5 ⁵ / ₁₆	---	1 ³ / ₄	1/2	3/4
103-K1	8x5	12x6	---	---	8x6	12x8	P1	---	4 ³ / ₁₆	---	---	3/8	1
103-K2	6x4	12x6	---	---	8x6	12x8	P10	---	4 ¹ / ₈	---	1 ¹ / ₂	1/2	3/4
C 110-K2	8x5	16x8	---	---	8x6	16x8	P10	---	5 ⁵ / ₁₆	---	1 ³ / ₄	3/8	7/8
SS 110-K2	8x5	16x8	---	---	8x6	16x8	P10	---	5 ⁵ / ₁₆	---	1 ³ / ₄	3/8	3/4
C 111-K2	9x6	18x8	---	---	10x8	16x8	P10	---	6 ¹ / ₄	---	2 ⁵ / ₁₆	1/2	3/4
SS 111-K2	10x6	18x8	---	---	10x8	16x8	P10	---	6 ¹ / ₄	---	2 ⁵ / ₁₆	1/2	3/4
---	---	---	12x8	16x8	---	---	P10	5 ¹ / ₄	6 ¹ / ₄	---	2 ⁵ / ₁₆	1/2	4 ¹ / ₈
124-K1	10x6	18x8	---	---	10x8	16x8	P1	---	6	---	---	5/8	1 ¹ / ₄
124-K2	8x5	16x7	---	---	8x6	16x8	P10	---	5 ¹ / ₄	---	1 ¹⁵ / ₁₆	3/8	7/8
H 124-K2	8x5	16x7	---	---	8x6	16x8	P10	---	5 ¹ / ₄	---	1 ¹⁵ / ₁₆	3/8	7/8
C 131-K1	8x5	12x6	---	---	8x6	12x8	P1	---	4 ¹ / ₈	---	---	3/8	1
C 131-K2	8x5	12x6	---	---	8x6	12x8	P10	---	4 ¹ / ₈	---	1 ¹ / ₂	1/2	1
SS 131-K2	8x5	12x6	---	---	8x6	12x8	P10	---	4 ¹ / ₈	---	1 ¹ / ₂	1/2	1
C 132-K2	12x6	20x8	---	---	12x8	16x8	P10	---	7 ¹ / ₂	---	2 ³ / ₄	1/2	1

Have dimensions certified for installation purposes.

*For 62-K1 Steel Attachment, consult Syntron Material Handling

Bucket Punching for Chains

Centrifugal Discharge Elevator Buckets on K Attachments (continued)

Chain attachment number	Nominal bucket size, inches						Punching	A	B	C	D	E	F
	Types AA, AA-RB		Type AC		Type SC								
	Min.	Max.	Min.	Max.	Min.	Max.							
145-K1	6x4	6x4	---	---	---	---	P1	---	2	---	---	3/16	5/8
SS 150 Plus-K2	12x6	20x8	---	---	12x8	16x8	P10	---	7 1/2	---	2 3/4	1/2	1
	---	---	12x8	16x8	---	---	P10	---	7 1/2	---	2 3/4	1/2	3 7/8
	---	---	18x10	18x10	---	---	P10	---	7 1/2	---	2 3/4	1/2	5 1/8
SS 150 Plus-K3	---	---	16x8	16x8	---	---	P15	5 1/4	11 1/2	7 1/2	2 3/4	1/2	3 7/8
	---	---	18x10	24x10	---	---	P15	6 1/2	11 1/2	7 1/2	2 3/4	1/2	5 1/8
188-K1	6x4	12x6	---	---	8x6	12x8	P1	---	3 3/4	---	---	3/8	1
C 188-K2	6x4	14x7	---	---	8x6	14x8	P10	---	4 3/16	---	1 1/4	5/16	3/4
SS 188-K1	6x4	12x6	---	---	8x6	12x8	P1	---	3 3/4	---	---	3/8	1
SS 188-K2	8x5	14x7	---	---	8x6	14x8	P10	---	4 3/16	---	1 1/4	5/16	3/4
SS 244-K2	10x6	18x10	---	---	10x8	16x8	P6	---	6	4 7/8	2 3/4	1/2	1
445-K1	6x4	6x4	---	---	---	---	P1	---	2 1/16	---	---	3/16	5/8
452-K1	6x4	6x4	---	---	---	---	P1	---	2 1/16	---	---	3/16	3/4
455-K1	6x4	6x4	---	---	---	---	P1	---	2	---	---	1/4	3/4
462-K1	6x4	8x5	---	---	8x6	8x6	P1	---	2 3/8	---	---	1/4	3/4
467-K1	6x4	10x6	---	---	8x6	10x8	P1	---	3	---	---	1/4	3/4
477-K1	6x4	10x6	---	---	8x6	10x8	P1	---	3	---	---	1/4	1
483-K1	6x4	10x6	---	---	8x6	10x8	P1	---	3 1/4	---	---	1	1
488-K1	6x4	12x6	---	---	8x6	12x8	P1	---	3 3/16	---	---	1	1
488-K2	6x4	12x6	---	---	8x6	12x8	P10	---	3 5/8	---	1 1/4	3/4	3/4
710-K2	10x6	18x8	---	---	10x8	16x8	P10	---	6 1/4	---	2 5/16	3/4	3/4

Chain attachment number	Nominal bucket size, inches						Punching	A	B	C	D	E	F	G	H
	Types AA, AA-RB		Type AC		Type SC										
	Min.	Max.	Min.	Max.	Min.	Max.									
730-K2	10x6	18x10	---	---	10x8	16x8	P10	---	6	---	2 5/8	1/2	1	---	---
823-K2	8x5	16x7	---	---	8x6	16x8	P10	---	5 1/4	---	1 11/16	3/8	3/4	---	---
825-K2	10x6	18x8	---	---	10x8	16x8	P10	---	6	---	2 5/8	1/2	3/4	---	---
830-K2	10x6	18x10	---	---	10x8	16x8	P10	---	6	---	2 5/8	1/2	7/8	---	---
847-K2	14x7	24x8	---	---	14x8	16x8	P6	---	9 3/4	8 5/8	3 1/2	3/4	1 1/4	---	---
SS 856-K2	10x6	18x10	---	---	10x8	16x8	P10	---	6 5/16	---	2 1/4	1/2	1	---	---
SS 856-K2	---	---	12x8	16x8	---	---	P10	5 1/4	6 5/16	---	2 1/4	1/2	4 1/8	---	---
	---	---	18x10	24x10	---	---	P10	6 1/2	6 5/16	---	2 1/4	1/2	5 3/8	---	---
SS 856-K3	---	---	16x8	16x8	---	---	P12	5 1/4	12 1/16	6 9/16	2 3/4	1/2	3 7/8	10 15/16	---
	---	---	18x10	24x10	---	---	P12	6 1/2	12 1/16	6 9/16	2 3/4	1/2	5 1/8	10 15/16	---
	---	---	12x8	16x8	---	---	P10	---	7 1/4	---	2 1/2	5/8	4	---	---
SS 856-K24	---	---	18x10	24x10	---	---	P10	---	7 1/4	---	2 1/2	5/8	5 1/4	---	---
SS 856-K35	---	---	16x8	16x8	---	---	P11	5 1/4	11 3/4	7 1/4	2 1/2	5/8	4	---	---
	---	---	18x10	24x10	---	---	P11	6 1/2	11 3/4	7 1/4	2 1/2	5/8	5 1/4	---	---
SS 1116-K2	6x4	12x7	---	---	8x6	12x8	P10	---	4	---	2	5/8	5/8	---	---
1130-K2	10x6	18x10	---	---	10x8	16x8	P10	---	6	---	2 5/8	1/2	1	---	---
1131-K2	10x6	18x10	---	---	10x8	16x8	P10	---	6	---	2 5/8	1/2	1	---	---
SS 2857-K44	---	---	18x10	24x10	---	---	P13	---	12	7	3 1/2	1/2	4 3/4	---	---
SS 2859-K44	---	---	18x10	24x10	---	---	P14	6 3/8	13	9	4 1/2	5/8	4 3/8	---	13 1/8
SS 2864-K44	---	---	27x12	27x12	---	---	P14	7 1/8	13	9	5 1/2	5/8	4 3/8	---	17 1/8
LXS 4019-K1	6x4	10x6	---	---	8x6	10x8	P1	---	2 3/4	---	---	3/8	1 3/8	---	---
LXS 4019-K2	6x4	10x6	---	---	8x6	10x8	P10	---	2 3/4	---	1 1/2	3/8	5/8	---	---
4103-K1	8x5	12x6	---	---	8x6	12x8	P1	---	4 3/16	---	---	3/8	1	---	---
4103-K2	8x5	12x6	---	---	8x6	12x8	P10	---	4 1/8	---	1 1/2	1/2	1	---	---
4124-K1	10x6	18x8	---	---	10x8	16x8	P1	---	6	---	---	5/8	1 1/2	---	---
4124-K2	8x5	16x7	---	---	8x6	16x8	P10	---	5	---	1 13/16	3/8	1	---	---
LXS 6238-K2	8x5	14x8	---	---	8x6	14x8	P10	---	4 1/4	---	2 5/8	1/2	1 5/8	---	---

Bucket Punching for Chains

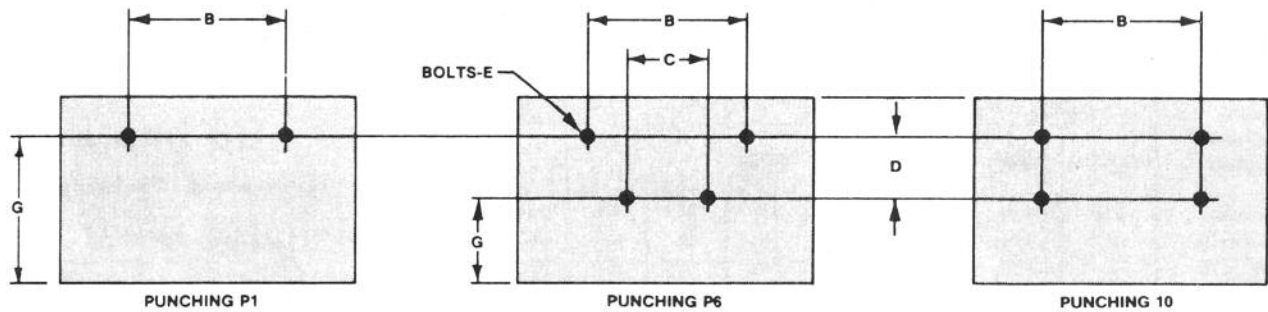

Continuous Elevator Buckets on K Attachments

Chain attachment number	Bucket size, inches								Punching	B	C	D	E	G
	Type HF		Type HFO		Type MF		Type LF							
	Min.	Max.	Min.	Max.	Min.	Max.	Min.	Max.						
SS 96-K2	10x7	14x8	10x7	14x8	10x7	14x8	10x7	12x8	P10	4 ³ / ₈	---	3	1/2	2 ³ / ₄
C 102B-K2	8x5	10x5	8x5	10x5	8x5	10x5	---	---	P10	5 ⁵ / ₁₆	---	1 ³ / ₄	3/8	17/8
SS 102B-K2	8x5	10x5	8x5	10x5	8x5	10x5	---	---	P10	5 ⁵ / ₁₆	---	1 ³ / ₄	3/8	17/8
C 102½-K2	8x5	10x5	8x5	10x5	8x5	10x5	---	---	P10	5 ⁵ / ₁₆	---	1 ³ / ₄	1/2	17/8
SS 102½-K2	8x5	10x5	8x5	10x5	8x5	10x5	---	---	P10	5 ⁵ / ₁₆	---	1 ³ / ₄	1/2	17/8
C 110-K2	10x7	16x8	10x7	16x8	10x7	18x8	10x7	16x8	P10	5 ⁵ / ₁₆	---	1 ³ / ₄	3/8	3 ³ / ₈
SS 110-K2	10x7	16x8	10x7	16x8	10x7	18x8	10x7	16x8	P10	5 ⁵ / ₁₆	---	1 ³ / ₄	3/8	3 ³ / ₈
C 111-K2	10x6	12x6	10x6	12x6	10x6	12x6	10x6	12x6	P10	6 ¹ / ₄	---	2 ⁵ / ₁₆	1/2	2 ³ / ₃₂
SS 111-K2	10x6	12x6	10x6	12x6	10x6	12x6	10x6	12x6	P10	6 ¹ / ₄	---	2 ⁵ / ₁₆	1/2	2 ³ / ₃₂
C 132-K2	10x7	16x8	10x7	16x8	12x7	20x8	12x7	20x8	P10	7 ¹ / ₂	---	2 ³ / ₄	1/2	27/8
SS 150 Plus K2	10x7	16x8	10x7	16x8	12x7	20x8	12x7	20x8	P10	7 ¹ / ₂	---	2 ³ / ₄	1/2	27/8
823-K2	8x5	10x5	8x5	10x5	8x5	10x5	---	---	P10	5 ¹ / ₄	---	11 ¹ / ₁₆	3/8	12 ⁹ / ₃₂
825-K2	8x5	10x5	8x5	10x5	8x5	10x5	---	---	P10	6	---	2 ⁵ / ₈	1/2	17/16
830-K2	10x7	16x8	10x7	16x8	10x7	18x8	10x7	16x8	P10	6	---	2 ⁵ / ₈	1/2	21 ⁵ / ₁₆
844-K2	10x7	16x8	10x7	16x8	10x7	18x8	10x7	16x8	P6	6	47/8	2 ³ / ₄	1/2	27/8
847-K2	12x7	16x8	12x7	16x8	14x7	20x8	14x7	20x8	P6	9 ³ / ₄	8 ⁵ / ₈	3 ¹ / ₂	3/4	3 ¹ / ₂
SS 856-K2	10x7	16x8	10x7	16x8	12x7	20x8	12x7	20x8	P10	6 ⁵ / ₁₆	---	2 ¹ / ₄	3/8	3 ¹ / ₈
SS 1116-K2	10x7	14x8	10x7	14x8	10x7	14x8	10x7	12x8	P10	4	---	2	3/8	3 ¹ / ₄
LXS 4019-K1	8x5	10x5	8x5	10x5	8x5	10x5	---	---	P1	2 ³ / ₄	---	---	3/8	2 ³ / ₄
LXS 4019-K2	8x5	10x5	8x5	10x5	8x5	10x5	---	---	P10	2 ³ / ₄	---	1 ¹ / ₂	3/8	2
LXS 6238-K2	10x7	14x8	10x7	14x8	10x7	14x8	10x7	12x8	P10	4 ¹ / ₄	---	2 ⁵ / ₈	1/2	21 ⁵ / ₁₆

Have dimensions certified for installation purposes.

CAUTION: Link-Belt® Elevator Buckets must be installed, operated and maintained in accordance with Syntron Material Handling Service Instructions. Failure to follow these instructions can result in serious personal injury, property damage or both.

Bucket Punching for Chains

Super Compacity Continuous Elevator Buckets on G Attachments

Chain attachment number	Bucket size, inches		A	B	D	E	F	L°
	Projection	Depth	inches					
SS 4850-G6	8¾	11 ⁵ / ₈	4 ⁹ / ₁₆	8¾	5¼	¾	1 ⁷ / ₈	28°30'
SS 4851-G10	12	17 ³ / ₈	6½	12 ⁷ / ₁₆	7 ¹ / ₈	½	4½	22°
SS 4852-G10	12	17 ³ / ₈	6½	12 ⁷ / ₁₆	7 ¹ / ₈	½	4½	22°
SS 4851-G11	12	17 ³ / ₈	6½	12 ⁷ / ₁₆	8½	5/8	4½	22°
SS 4852-G11	12	17 ³ / ₈	6½	12 ⁷ / ₁₆	8½	5/8	4½	22°
SS 4851-G100	12	17 ³ / ₈	6½	12 ⁷ / ₁₆	8½	5/8	7	22°
SS 4852-G100	12	17 ³ / ₈	6½	12 ⁷ / ₁₆	8½	5/8	7	22°

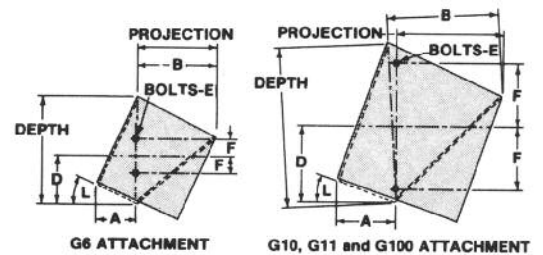

Type AA Centrifugal Discharge Elevator Buckets on G Attachments

Nominal bucket projection, inches	A	B	Chain, attachment number	Min. projection, inches	C	D	E	F
	inches				inches			
4	1 ⁵ / ₈	2 ¹ / ₈	45-G1	4	1 ⁷ / ₃₂	---	3 ¹ / ₁₆	---
5	2	2 ⁵ / ₈	52-G1	4	1 ⁷ / ₃₂	---	3 ¹ / ₁₆	---
6	2 ⁵ / ₈	3 ¹ / ₈	62-G1	5	1	---	¼	---
7	2½	3¾	77-G6	6	5/8	9/16	¼	¼
8	2 ⁵ / ₈	4 ⁷ / ₈	H78-G1	6	1 ⁵ / ₁₆	---	¼	---
10	3¾	5 ⁵ / ₈	88-G6	6	7/8	2 ¹ / ₃₂	¼	9/32
			C102B-G6	10	1 ¹ / ₁₆	1 ¹ / ₁₆	3/8	7/16
			C110-G6	10	1 ¹ / ₁₆	1 ¹ / ₁₆	3/8	7/16
			C111-G6	10	1 ¹ / ₁₆	1 ¹ / ₁₆	3/8	15/32
			C111SP-G6	10	1 ¹ / ₁₆	1 ¹ / ₁₆	3/8	15/32
			C131-G6	6	2 ⁷ / ₃₂	1 ¹ / ₁₆	3/8	9/32
			C188-G6	6	2 ⁷ / ₃₂	1 ¹ / ₁₆	¼	9/32
			462-G1	5	1	---	¼	---
			477-G1	6	1 ⁵ / ₁₆	---	5/16	---
			488-G6	6	2 ⁷ / ₃₂	1 ¹ / ₁₆	¼	9/32
			730-G6	10	1¾	---	3/8	5/8
			825-G6	10	1¾	---	3/8	5/8
			830-G6	10	1¾	---	3/8	5/8
			4103-G6	6	2 ⁷ / ₃₂	1 ¹ / ₁₆	3/8	9/32

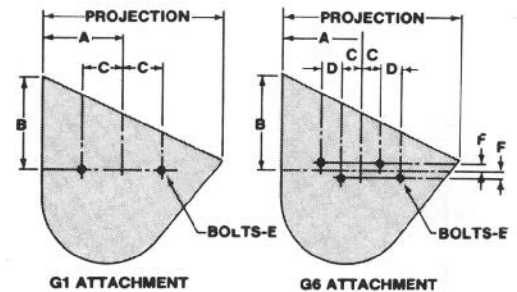

Have dimensions certified for installation purposes.

▲ Minimum bucket size which will accommodate attachment

Bucket Punching for Chains

Types AA and SC Centrifugal Discharge Elevator Buckets on A and B Wing Attachments

Wing number	Nominal bucket projection, inches	Type AA		Type SC		C	E	F
		A	B	A	B			
inches								
2A	10	3 ³ / ₄	5 ³ / ₈	---	---	2	1/2	15/8
3A	10	3 ³ / ₄	5 ³ / ₈	---	---	2	1/2	15/8
4A	10	3 ³ / ₄	5 ³ / ₈	---	---	2	1/2	15/8
5A	5	---	---	---	---	1 ³ / ₈	5/16	11/16
	5 ¹ / ₂	---	---	---	---	1 ³ / ₈	5/16	11/16
	6	2 ¹ / ₂	3 ¹ / ₂	2 ¹ / ₂	2 ³ / ₄	1 ³ / ₈	5/16	11/16
	6 ¹ / ₂	---	---	---	---	1 ³ / ₈	5/16	11/16
6A	7	2 ¹ / ₂	4	---	---	1 ³ / ₈	5/16	11/16
	6 ¹ / ₂	---	---	---	---	1 ¹¹ / ₁₆	3/8	5/8
	7	2 ⁵ / ₈	4	---	---	1 ¹¹ / ₁₆	3/8	5/8
7A	8	3	4 ¹ / ₂	3	3 ³ / ₄	2	3/8	1 ¹ / ₈
	10	3 ³ / ₄	5 ³ / ₈	---	---	2	3/8	1 ¹ / ₈
30A	10	3 ³ / ₄	5 ³ / ₈	---	---	2	1/2	1 ³ / ₄
37A	4 ¹ / ₂	---	---	---	---	1 ¹ / ₄	5/16	9/16
	5	---	---	---	---	1 ¹ / ₄	5/16	9/16
	5 ¹ / ₂	---	---	---	---	1 ¹ / ₄	5/16	9/16
	6	2 ¹ / ₂	3 ¹ / ₄	2 ¹ / ₂	2 ³ / ₄	1 ¹ / ₄	5/16	9/16
	6 ¹ / ₂	---	---	---	---	1 ¹ / ₄	5/16	9/16
39A	7	2 ¹ / ₂	4	---	---	1 ¹ / ₄	5/16	9/16
	4 ¹ / ₂	---	---	---	---	1 ¹ / ₁₆	5/16	11/16
	5	2	2 ³ / ₄	---	---	1 ¹ / ₁₆	5/16	11/16
	5 ¹ / ₂	---	---	---	---	1 ¹ / ₁₆	5/16	11/16
1B	6	2 ¹ / ₄	3 ¹ / ₄	2 ¹ / ₂	2 ³ / ₄	1 ¹ / ₁₆	5/16	11/16
	6 ¹ / ₂	---	---	---	---	1 ¹ / ₁₆	5/16	11/16
	7	2 ¹ / ₂	4	---	---	1 ¹ / ₁₆	5/16	11/16
	7	---	---	---	---	1 ¹ / ₁₆	5/16	11/16
2B	6 ¹ / ₂	---	---	---	---	---	1/2	1 ⁷ / ₈
	7	2 ¹ / ₂	4	---	---	---	1/2	1 ⁷ / ₈
	8	2 ⁵ / ₈	4 ¹ / ₂	3	3 ³ / ₄	---	1/2	1 ⁷ / ₈
	10	3 ³ / ₄	5 ³ / ₈	---	---	---	1/2	1 ⁷ / ₈
2B	3 ¹ / ₂	---	---	---	---	---	1/4	7/8
	4	1 ¹ / ₂	2 ³ / ₈	---	---	---	1/4	7/8
	4 ¹ / ₂	---	---	---	---	---	1/4	7/8
	5	2	2 ³ / ₄	---	---	---	1/4	7/8
	5 ¹ / ₂	---	---	---	---	---	1/4	7/8

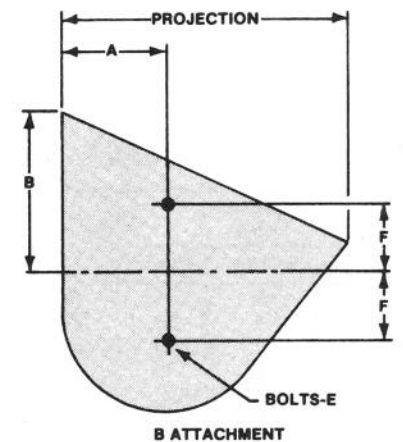
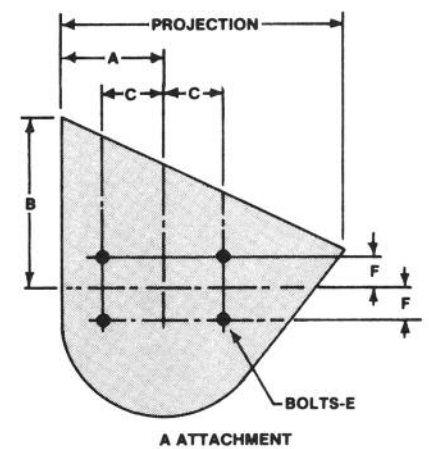

Have dimensions certified for installation purposes.

Bucket Punching for Belts

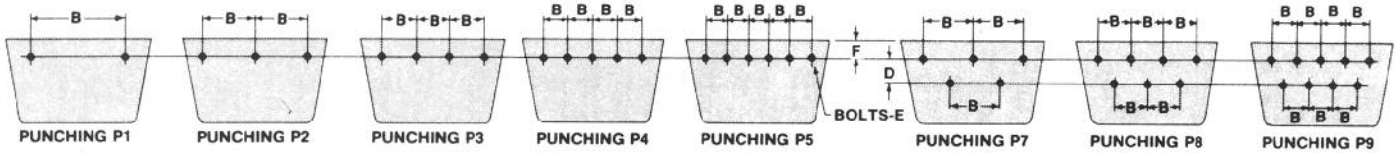

Types AA, AA-RB, and SC Centrifugal Discharge Elevator Buckets

Nominal bucket length, inches	Punching	Belt width, inches	B	D	E	F
			inches			
3	P1	4	1 ³ / ₈	---	1/4	3/4
4	P1	5	2 ⁵ / ₁₆	---	1/4	3/4
5	P1	6	3 ³ / ₁₆	---	1/4	1
6	P1	7-8	4 ³ / ₈	---	1/4	1
7	P2	8	2 ¹ / ₂	---	1/4	1
8	P7	9-10	3	1	1/4	7/8
9	P7	10	3	1	1/4	7/8
10	P7	11-12	3 ¹ / ₂	1	5/16	7/8
11	P7	12	4	1	5/16	7/8
12	P7	13-14	4 ¹ / ₂	1	5/16	7/8
13	P8	14	3 ¹ / ₂	1	5/16	7/8
14	P8	15-16	4	1	5/16	7/8
15	P8	16	4	1	5/16	7/8
16	P8	18	4 ¹ / ₂	1	5/16	7/8
17	P8	18	4 ¹ / ₂	1	5/16	7/8
18	P8	20	5	1	5/16	7/8
19	P9	20	4	1	5/16	7/8
20	P9	22	4	1	5/16	7/8
21	P9	22	4 ¹ / ₂	1	5/16	7/8
22	P9	24	4 ¹ / ₂	1	5/16	7/8
23	P9	24	5	1	5/16	7/8
24	P9	26	5	1	5/16	7/8

Types HF, HFO, MF, and LF Continuous Elevator Buckets

Bucket size inches			Punching	Belt width, inches	B	D	E	F
Length	Projection	Depth			inches			
8	5	7 ³ / ₄	P7	9-10	3	1	1/4	3 ³ / ₈
8	5	8 ¹ / ₂	P7	9-10	3	1	1/4	3 ³ / ₈
9	6	9 ¹ / ₄	P7	10	3	1	1/4	4 ¹ / ₈
10	5	7 ³ / ₄	P7	11-12	3 ¹ / ₂	1	5/16	3 ³ / ₈
10	5	8 ¹ / ₂	P7	11-12	3 ¹ / ₂	1	5/16	3 ³ / ₄
10	6	9 ¹ / ₄	P7	11-12	3 ¹ / ₂	1	5/16	4 ¹ / ₈
10	6	10	P7	11-12	3 ¹ / ₂	1	5/16	4 ¹ / ₂
10	7	11 ⁵ / ₈	P7	11-12	3 ¹ / ₂	1	5/16	5 ⁵ / ₁₆
10	7	12 ¹ / ₂	P7	11-12	3 ¹ / ₂	1	5/16	5 ³ / ₄
10	8	11 ⁵ / ₈	P7	11-12	3 ¹ / ₂	1	5/16	5 ⁵ / ₁₆
11	6	9 ¹ / ₄	P7	12	4	1	5/16	4 ¹ / ₈
12	5	7 ³ / ₄	P7	13-14	4 ¹ / ₂	1	5/16	3 ³ / ₈
12	6	9 ¹ / ₄	P7	13-14	4 ¹ / ₂	1	5/16	4 ¹ / ₈
12	6	10	P7	13-14	4 ¹ / ₂	1	5/16	4 ¹ / ₂
12	7	11 ⁵ / ₈	P7	13-14	4 ¹ / ₂	1	5/16	5 ⁵ / ₁₆
12	7	11 ³ / ₄	P7	13-14	4 ¹ / ₂	1	5/16	5 ³ / ₈
12	7	12 ¹ / ₂	P7	13-14	4 ¹ / ₂	1	5/16	5 ³ / ₄
12	8	11 ⁵ / ₈	P7	13-14	4 ¹ / ₂	1	5/16	5 ⁵ / ₁₆
12	8	12 ¹ / ₂	P7	13-14	4 ¹ / ₂	1	5/16	5 ³ / ₄
14	7	11 ⁵ / ₈	P8	15-16	4	1	5/16	5 ⁵ / ₁₆
14	7	12 ¹ / ₂	P8	15-16	4	1	5/16	5 ³ / ₄

Bucket size inches			Punching	Belt width, inches	B	D	E	F
Length	Projection	Depth			inches			
14	8	11 ⁵ / ₈	P8	15-16	4	1	5/16	5 ⁵ / ₁₆
14	8	11 ³ / ₄	P8	15-16	4	1	5/16	5 ³ / ₈
14	8	12 ¹ / ₂	P8	15-16	4	1	5/16	5 ³ / ₄
16	7	11 ³ / ₄	P8	18	4 ¹ / ₂	1	5/16	5 ³ / ₈
16	8	11 ⁵ / ₈	P8	18	4 ¹ / ₂	1	5/16	5 ⁵ / ₁₆
16	8	12 ¹ / ₂	P8	18	4 ¹ / ₂	1	5/16	5 ³ / ₄
16	12	17 ⁵ / ₈	P8	18	4 ¹ / ₂	1	5/16	8 ⁵ / ₁₆
16	12	18 ⁵ / ₈	P8	18	4 ¹ / ₂	1	5/16	8 ¹³ / ₁₆
18	8	11 ⁵ / ₈	P8	20	5	1	5/16	5 ⁵ / ₁₆
18	10	15	P8	20	5	1	5/16	7
20	8	11 ⁵ / ₈	P9	22	4	1	5/16	5 ⁵ / ₁₆
20	12	17 ⁵ / ₈	P9	22	4	1	5/16	8 ⁵ / ₁₆
20	12	18 ⁵ / ₈	P9	22	4	1	5/16	8 ¹³ / ₁₆
24	10	11 ⁵ / ₈	P9	26	5	1	5/16	5 ⁵ / ₁₆
24	12	17 ⁵ / ₈	P9	26	5	1	5/16	8 ⁵ / ₁₆
24	12	18 ⁵ / ₈	P9	26	5	1	5/16	8 ¹³ / ₁₆

Have dimensions certified for installation purposes.

Syntron Material Handling

Corporate Office

P.O. Box 1370
Tupelo, Mississippi 38802
Phone: 662.869.5711
Fax: 662.869.7449

Proven Engineered Products – Complete Material Handling Solutions

Syntron®
Link-Belt®

Saltillo
2730 Hwy 145 South
Saltillo, Mississippi 38866
Phone: 662.869.5711
Fax: 662.869.7493
Toll Free: 800.356.4898
info@syntronmh.com

Changshu
#2 Road No. 1
Changshu Export Processing Zone
Changshu, Jiangsu, China 215513
Phone: +86 0512.52299002
Fax: +86 0512.52297228
info@syntronmh.com